

No. 17 | 2012

Staff Memo

Robustifying optimal monetary policy in Norway

Mathis Mæhlum, Monetary Policy

Staff Memos present reports and documentation written by staff members and affiliates of Norges Bank, the central bank of Norway. Views and conclusions expressed in Staff Memos should not be taken to represent the views of Norges Bank.

© 2012 Norges Bank

The text may be quoted or referred to, provided that due acknowledgement is given to source.

Staff Memo inneholder utredninger og dokumentasjon skrevet av Norges Banks ansatte og andre forfattere tilknyttet Norges Bank. Synspunkter og konklusjoner i arbeidene er ikke nødvendigvis representative for Norges Banks.

© 2012 Norges Bank

Det kan siteres fra eller henvises til dette arbeid, gitt at forfatter og Norges Bank oppgis som kilde.

ISSN 1504-2596 (online only)

ISBN 978-82-7553-6+* !- (online only)

Robustifying Optimal Monetary Policy in Norway

Mathis Mæhlum



Master's thesis for the Master of Philosophy in Economics degree
Department of Economics
UNIVERSITY OF OSLO

Submitted May 2012

Abstract

Monetary policy is usually modelled as either simple rules or optimal policy. While the former are often seen as incomplete and unrealistic for practical policymaking, the latter can yield catastrophe should the policymaker's macroeconomic model be wrong. I seek to "robustify" the optimal policy from Norges Bank's reference model, NEMO, when there are alternative possible models with very different structural properties. This is done by punishing deviations from a simple interest rate rule in a "modified" welfare loss function. I consider several simple rule for this purpose, among them the simple Taylor rule and several rules that are optimized for the alternative models. The combination of optimal policy and simple rules turn out to be effective for avoiding large welfare losses in the alternative models and creating an acceptable trade-off. In addition, the method is flexible and can easily be implemented by central banks.

Preface

This thesis has been written as part of the Robust monetary policy project at Norges Bank's research department (PPO-FA), where I have been employed as a research assistant. I would like to thank my supervisor Øistein Røisland for his constructive feedback and for always being available when I needed him. Tommy Sveen has provided helpful comments and guidance during the whole process. This work is to a large extent based on the work of Tommy and Øistein, and the thesis could not have been written without their help. In addition, the following people have given invaluable help in the process: Junior Maih, Pelin Ilbas, Martin Seneca, Leif Brubakk, Bjørn Naug, Cathrine Bolstad Træe, Kenneth Sæterhagen Paulsen and Ørjan Robstad.

A special thanks goes to Maria Brunborg Hoen. Parts of this thesis have been written in collaboration with Maria, whose master's thesis is on robust simple rules for the same four models that I use (see Hoen 2012). We have shared the work of writing about the models. The descriptions of NEMO and Credit NEMO in chapter 2 and the complete versions of NEMO and NAM in appendix A are written by Maria. In addition, all the Bayesian rules that are analyzed in section 4.3.2 are taken from her thesis.

Contents

Contents	ii
1 Introduction and summary	1
2 The models	4
2.1 DSGE models and new Keynesian economics	4
2.1.1 A simple new Keynesian model	4
2.1.2 General form and stability conditions	6
2.2 NEMO	7
2.3 Credit NEMO	11
2.4 LGM	12
2.4.1 Description of the model	12
2.4.2 Estimation	14
2.5 NAM	16
2.6 Transmission of monetary policy	18
3 Theoretical background: optimal policy, simple rules, and robustness	22
3.1 Social welfare and the loss function	22
3.2 Optimal policy	26
3.2.1 Rules versus discretion	26
3.2.2 Optimal commitment policy: targeting rules and direct instrument rules	27
3.3 Simple rules	29
3.3.1 Optimal policy versus simple rules	31
3.4 Robust monetary policy	32
3.4.1 Robust control	33
3.4.2 Robust simple rules in non-nested models	35
3.4.3 Robustifying optimal policy	36

4	Results	38
4.1	Optimal implementable policy in NEMO	38
4.1.1	The robustness of optimal policy	40
4.2	Method and loss measures	42
4.2.1	Comparing losses: excess loss and implied inflation premium	43
4.2.2	Simple rules	45
4.3	Robustifying optimal policy	46
4.3.1	The Taylor rule	46
4.3.2	Bayesian rules	51
4.3.3	The minmax rule	60
4.3.4	An alternative loss function	62
4.3.5	Weighting simple rules and optimal policy	64
4.4	Discussion of results and conclusion	65
4.4.1	Possible extensions	66
5	Bibliography	68
A	Complete models	74
A.1	NEMO	74
A.1.1	List of variables	74
A.1.2	Model	76
A.2	NAM	79
A.2.1	List of variables	79
A.2.2	Model	80
A.3	LGM	82
A.3.1	List of variables	82
A.3.2	Model	83
A.3.3	Estimation results	83
B	Derivation of the implied inflation premium	86
C	Optimal implementable rules	88

Chapter 1

Introduction and summary

Uncertainty is not just an important feature of the monetary policy landscape; it is the defining characteristic of that landscape (Greenspan 2003).

As the quote from former Federal Reserve chairman Alan Greenspan emphasizes, the practice of monetary policy is surrounded by a great deal of uncertainty. While the previous decades have seen great advances in the modelling of short run macroeconomic fluctuations, researchers and practitioners alike have not landed on one single model or even a single type of models. Different assumptions about issues such as which shocks drive aggregate fluctuations, how wages and prices are set on the micro level, the nature of capital formation, and the degree of competition in markets can lead to very different conclusions about how the economy functions on the macro level. This in turn leads to varying prescriptions for monetary policy.

In this thesis I investigate how monetary policy in Norway can be made robust to uncertainty about the functioning of the economy. In most developed countries today, monetary policy is determined by an independent central bank that controls the short term nominal interest rate¹. The most important objectives are a low and stable inflation rate and the stabilization of output around a trend. These goals can be expressed by means of a quadratic welfare loss function. In the monetary policy literature, the interest rate is often modelled as a rule that specify feedback from certain macroeconomic variables (such as inflation and the output gap) to the rate. The optimal policy is the rule that minimizes the loss function given the constraints of the model. A simple instrument rule, by contrast, is based only on a limited subset of information and will not in general implement the optimum. The advan-

¹In the following, I take the terms *central bank* and *policymaker* to mean the same things. I disregard the details of the decision-making process. In Norges Bank, the key policy rate is the sight deposit rate, which is the interest rate on private banks' deposits in the central bank. This rate is set by the Executive Board, which consists of two inside (full-time) and five outside (part-time) members.

tage of simple rules is that they have been found to be more robust to uncertainty about the structure of the economy; that is, when the policymaker does not have complete confidence in any single model, simple rules can provide an insurance that optimal policy can not (Levin and Williams 2003; Taylor and Williams 2010).

I assume that the policymaker has one reference model, but lacks complete confidence in this specification. Instead, he also considers three alternative models that have very different structural properties. Thus I depart from the common robust control framework, which assumes that the alternative models are all varieties of — and are hard to distinguish from — the reference (Hansen and Sargent 2008). My reference model is the Norwegian Economy Model (NEMO), a medium scale, open economy new Keynesian model that is Norges Bank's main model for monetary policy analysis. The set of alternative models consists of a version of NEMO that includes a financial accelerator mechanism through the effect of house prices on credit (Credit NEMO); a smaller scale new Keynesian model with incomplete pass-through of exchange rate fluctuations (LGM); and a macroeconometric model of the Norwegian economy that is distinguished from the other three models in that it assumes neither forward-looking agents nor general equilibrium (NAM). I re-estimate LGM on Norwegian data.

While NEMO is the policymaker's main model and therefore the point of departure for evaluating monetary policy, this policy should also yield a reasonably good outcome if one of the alternative models actually provides a better description of reality. I seek to "robustify" the optimal policy rule in NEMO by striking a compromise: the chosen rule should be close to the optimal policy in NEMO only to the extent that this does not lead to too high welfare losses in the other models. This is achieved by using a simple instrument rule as a "cross-check" on the optimal policy. I follow Ilbas et al. (2012) in using a modified loss function to operationalize the preference for robustness. In addition to the standard terms, this loss function penalizes departures from a simple rule. It should not be taken as representing the true preferences of the policymaker, but rather as a means for making the optimal policy robust to model uncertainty. By increasing the weight given to the simple rule relative to stabilization of NEMO, we will get a policy that is closer to the simple rule. Thus a main issue is to find a simple rule and a weight on this rule in order to get a reasonable compromise between a low welfare loss in NEMO and robustness to model uncertainty.

For the optimal NEMO policy to be implementable in the alternative models, I must approximate it with what I call an implementable instrument rule that includes only variables present in all of the models. I find that an eight parameter specification provides a reasonably good specification. I consider three types of simple rules as cross-checks in the modified loss function. First, the simple Taylor rule (Taylor 1993), which is well known and widely considered to be robust to model uncertainty. Second, simple Bayesian rules that minimize an

average of the losses in each of the alternative models. Third, a minmax rule that minimizes the maximum loss across all the alternative models. The Taylor rule provides a benchmark that the optimized rules can be compared to.

The main problem with the optimal NEMO policy is that it creates instability in NAM. Even a low weight on the *ad hoc* Taylor rule in the modified loss function can provide insurance against this scenario, and the resulting policy rule will generate acceptable losses in all the models. However, adding some inertia in the interest rate and optimizing over the coefficients in the rule gives better performance. The three parameter Bayesian rule and the minmax rule outperform the Taylor rule in terms of the minimum weighted loss across all the models. There are two main differences. First, the optimal weight on the simple rule should be higher for the optimized three parameter rules. Second, the models are more "fault tolerant" with respect to the choice of weight, in the sense that the losses are acceptable for a wider range of values of this weight. I find that it is possible to robustify optimal policy in the reference model by means of the modified loss function and a simple, robust rule. The approach is both flexible and implementable, and thus it can be recommended for practical policymaking.

The rest of this thesis is organized as follows. In chapter 2 the four models are described. Sections 2.2 and 2.3 have been written by Maria Brunborg Hoen. Chapter 3 provides the theoretical background to the issues of optimal policy, simple rules and robustness. In section 3.1 I show how the flexible inflation targeting regime can be operationalized by means of a welfare loss function. Sections 3.2 and 3.3 contrast optimal monetary policy with the use of simple instrument rules, and I discuss the relative merits of the two approaches. Section 3.4 discusses the alternative approaches to robustness in the literature, and I introduce my method and the reasoning behind it. Chapter 4 contains the results. First, in section 4.1 I show how the optimal state-contingent NEMO policy can be approximated by an implementable instrument rule. Section 4.2 introduces the setup for my simulations as well as two measures of performance: excess loss and implied inflation premium. Section 4.3 contains the main results from the robustification of optimal policy, while a summary is provided in section 4.4. The equations that constitute NEMO, NAM and LGM are given in appendix A.

I employ the Dynare software platform for estimation and simulation of the models as well as calculation of optimal policy. Dynare is an open source program developed to handle a wide range of economic models, in particular DSGE models with rational expectations. The algorithm for finding optimal simple rules has been developed by Junior Maih for Norges Bank². Dynare runs in Matlab, in which I have also done other calculations.

²Dynare can be downloaded from <http://www.dynare.org/>. The OSR algorithm is not publicly available.

Chapter 2

The models

2.1 DSGE models and new Keynesian economics

Of the four models I consider in this thesis, one (NAM) is a completely backward-looking model, while the rest are dynamic stochastic general equilibrium (DSGE) models. The latter are dynamic models of the macroeconomy based on agents solving intertemporal optimization problems and the assumption that all markets clear in each period. In addition, there is some aggregate uncertainty in e.g. total factor productivity or government policy generated by exogenous, stochastic shocks. The term "DSGE model" comprises a wide variety of models, however, from the simplest real business cycle (RBC) perfect competition models to new Keynesian models with short run nominal rigidities.

2.1.1 A simple new Keynesian model

In most of these models, the demand side consists of a representative consumer who maximizes the discounted sum of future utilities from consumption and leisure, subject to a sequence of flow budget constraints. He is allowed to invest in a risk-free pure discount bond that pays a time-varying interest rate. Optimization leads to a consumption Euler equation, which in its simplest log-linearized form can be written:

$$c_t = E_t c_{t+1} - \alpha(i_t - E_t \pi_{t+1}) \tag{2.1}$$

where c_t is (log) consumption, i_t the nominal interest rate and π_t the inflation rate. Consumption smoothing means that consumption today will move with expected consumption tomorrow, and a higher real interest rate — by increasing the pay-off from saving relative to

consuming — leads to less consumption today.

The simplest RBC models — such as the one analyzed by Gali (2008: ch. 2) — are not well fitted for policy analysis. In these perfect competition models, firms maximize profits for given prices and wages. As a result, prices are perfectly flexible even in the short run, and all real variables — even the real interest rate — are determined by non-monetary fundamentals. This implies that any change in the policy rate is perfectly offset by a change in the inflation rate. Monetary policy is effective in determining inflation, but it has no impact on the real variables that determine welfare.

This is changed when we allow for nominal price rigidities, as prices will no longer follow interest rates in the short run. New Keynesian models preserve the dynamic general equilibrium framework of RBC theory while abandoning the assumption of perfect competition in order to provide microfoundations for nominal rigidities (Dixon 2008). The source of this rigidity might vary, but usually there is some restriction on how firms set prices. The common Calvo pricing mechanism (Calvo 1983) is used in LGM and many other new Keynesian models. Each monopolistic firm sets the price for its own good, but is only allowed to do so when it receives a random signal. There is a fixed probability that any firm is allowed to change its price in any given period, which results in a constant average number of periods between re-optimizations. This kind of rigidity on the supply side creates a role for monetary policy in stabilizing both prices and output; changes in the short term interest rate are not matched one-for-one by changes in expected inflation, and so the policymaker is able to influence the real interest rate.

Gali (2008: ch. 3) derives a simple closed economy new Keynesian model which has a demand side described by the Euler equation above and a supply side characterised by Calvo price setting and monopolistic competition among a large number of firms. This model serves as the basis for the more complicated models that I employ in this thesis. There is a continuum of firms, each supplying a differentiated good and seeking to maximize the discounted market value of its profits. Due to the Calvo restriction on pricing, they choose a price equal to a markup over a weighted average of expected future marginal costs, the weights being proportional to the probability that the price will remain the same at each future date. When aggregating across all firms, inflation can be expressed as the discounted sum of expected deviations of average marginal cost from the steady state value:

$$\pi_t = \lambda \sum_{k=0}^{\infty} \beta^k E_t \{ \widehat{m}c_{t+k} \} \tag{2.2}$$

When average marginal costs are expected to be above their long run (steady state) level,

firms that are allowed to reset their prices now will set higher prices than the current average, as they take into account future costs. Thus prices will rise today. Now, marginal costs are proportional to output. Taking into account that the underlying, exogenous technological progress is the same whether prices are perfectly flexible or not, the marginal cost gap can be expressed in terms of the difference between actual output and "potential" (or "natural") output in logs, which is called the the output gap. We get the following relation between inflation today, next period's inflation rate and the output gap y_t , called the new Keynesian Phillips curve:

$$\pi_t = \beta E_t \{ \pi_{t+1} \} + \kappa y_t + \epsilon_t \quad (2.3)$$

where ϵ_t is a cost-push shock that is often added to the Phillips curve in an *ad hoc* manner. All shocks in the models I consider in this thesis are normally distributed, serially uncorrelated and independent.

Assuming clearing of the goods market and using the Euler equation 2.1, we get the dynamic IS equation:

$$y_t = E_t y_{t+1} - \alpha (i_t - E_t \pi_{t+1} - r_t^n), \quad (2.4)$$

where r_t^n is the natural real interest rate, which is determined by technological changes. Adding an equation that determines the interest rate i_t , we get a three equation system that constitutes a benchmark new Keynesian model on log-linearized form.

2.1.2 General form and stability conditions

Most linearized DSGE models can be written compactly on the following general form (Blanchard and Kahn 1980; Svensson 1999):

$$\begin{bmatrix} X_{t+1} \\ E_t x_{t+1} \end{bmatrix} = A \begin{bmatrix} X_t \\ x_t \end{bmatrix} + B i_t + C Z_t, \quad (2.5)$$

where X_t is a column vector of variables that are predetermined at time t , x_t is a column vector of variables that are non-predetermined, i_t is the interest rate (for now treated as exogenous), A , B and C are parameter matrices, and Z_t is a column vector of exogenous shocks realized at time t . A variable that is predetermined at time t is a function only of

variables known at time t , so that $E_t X_{t+1} = X_{t+1}$ (Blanchard and Kahn 1980). A variable that is non-predetermined at time t can depend on any variable that is not realized before time t . In the case of a completely backward-looking model such as NAM, x_t is the zero vector, and the model is then a simple system of stochastic difference equations expressed in matrix form. The general form given by equation 2.5 can also accommodate models that contain variables either lagged more than one period or with expectations of variables more than one period ahead. This is achieved simply by defining new variables in the system.

The canonical New Keynesian model presented above can be written on the form of equation 2.5. Assume for simplicity that $r_t^n = v_t$, a normally distributed and serially uncorrelated shock. In this model, both y_t and π_t are non-predetermined at t . Thus the model is written:

$$\begin{bmatrix} E_t \pi_{t+1} \\ E_t y_{t+1} \end{bmatrix} = \begin{bmatrix} \frac{1}{\beta} & -\frac{\kappa}{\beta} \\ -\frac{\alpha}{\beta} & 1 + \frac{\alpha\kappa}{\beta} \end{bmatrix} \begin{bmatrix} \pi_t \\ y_t \end{bmatrix} + \begin{bmatrix} 0 \\ \alpha \end{bmatrix} i_t + \begin{bmatrix} -\frac{1}{\beta} & 0 \\ \frac{\alpha}{\beta} & -\alpha \end{bmatrix} \begin{bmatrix} \epsilon_t \\ \nu_t \end{bmatrix} \quad (2.6)$$

Adding an equation for i_t , such as the simple Taylor rule (see section 3.3), allows us to solve the system in equation 2.5 by standard methods developed for linear rational expectations models (e.g. Blanchard and Kahn 1980; King and Watson 1998). The term $B i_t$ then vanishes, and instead we have a new matrix A' in front of the vector of time t endogenous variables. As shown by Blanchard and Kahn (1980), a necessary condition for a unique non-explosive solution to the system is that the number of eigenvalues of A' with modulus greater than one is equal to the number of non-predetermined variables. If there are more eigenvalues outside the unit circle than non-predetermined variables, there can be only explosive solutions. An example of such a situation is one where monetary policy is unable to contain inflation expectations, such that expectations of ever higher inflation are self-fulfilling. If the number of eigenvalues outside the unit circle is less than the number of non-predetermined variables, on the other hand, there are infinitely many solutions. In the following, the former situation is called instability, the latter indeterminacy. In new Keynesian models, monetary policy is typically vital for bringing about a unique, stable solution.

2.2 NEMO

The Norwegian Economy Model, NEMO (Brubakk et al. 2006), is a New Keynesian DSGE model used by Norges Bank for policy evaluation and forecasting. It is a model of a small open economy consisting of two countries, home and foreign, interpreted as Norway and its trading partners, and two sectors, one producing intermediate goods and one producing a single final good. The model economy is a representation of the Norwegian mainland

economy, with the petroleum sector entering as an exogenous process for oil investments. The foreign economy is modelled symmetrically to the home economy, but enter in the form of exogenous variables, such that Norway has no influence on its trading partners. All variables in NEMO are detrended with a common stochastic growth trend. We use a first-order Taylor approximation of the model. All variables except growth rates and interest rates are expressed in log deviations from the respective (log) steady state values.

The economy consists of a continuum of infinitely lived households that are divided into two types, "savers" and "spenders", who both supply labour services to the intermediate goods sector. The share slc of spenders are rule-of-thumb consumers who spend their total labour income every period. The share $(1 - slc)$ of savers have access to the credit market and choose consumption and saving plans that maximize expected utility over the lifetime subject to a budget constraint, which leads to the following Euler equation:

$$c_t^{sa} = f_{191} E_t c_{t+1}^{sa} + f_{192} c_{t-1}^{sa} - f_{193} E_t \{i_t - \pi_{t+1}\} - f_{194} \pi_t^Z + f_{195} z_t^U \quad (2.7)$$

where c_t^{sa} is the savers' consumption, π_t^Z is a shock to the growth trend and z_t^U is a preference shock that raises the marginal utility of consumption relative to leisure. Savers are forward-looking and wish to smooth consumption over time, and due to habit persistence, current consumption also depends on last period's consumption. A temporary rise in growth reduces the value of (detrended) consumption, and households thereby postpone consumption.

The savers invest in domestic and foreign bonds, receive all dividends from firms, pay lump sum taxes and set nominal wages taking firms' labour demand into account. They have some degree of monopoly power in the labour market, and hence the resulting wages are above the competitive wages. Spenders receive the average wage rate of the savers and simply supply the amount of labour demanded at this wage. There are quadratic costs of adjusting wages that make wage growth, π_t^w , respond sluggishly to shocks. This variable thus depends on past and future wage growth, deviations of the actual wage from the optimal wage (equal to the marginal rate of substitution between consumption and leisure), $(w_t - mrs_t)$, and the degree of bargaining power represented by the substitution elasticity between labour inputs, ω_t :

$$\pi_t^W = \frac{\beta}{1 + \beta} E_t \pi_{t+1}^W + \frac{1}{1 + \beta} \pi_{t-1}^W - f_{231} (w_t - mrs_t) - f_{232} \omega_t \quad (2.8)$$

Figure 2.1 shows the structure of NEMO. Production of the final good, A, is done using

a combination of imported and domestically produced intermediates, respectively M and Q , with the shares being given by the degree of "home bias", i.e. the relative preferences for input factors produced in the home economy. The final good is used for consumption, C , capital investments in the intermediate sector, I , government spending, G , and oil investments, $IOIL$. The only source of imports in the economy are the imported intermediate goods, T^* , and exports consist purely of domestically produced intermediate goods, M^* .

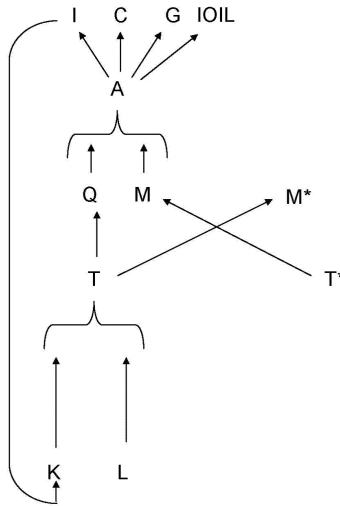

Figure 2.1: An overview of the production structure in NEMO (Brubakk et al. 2006).

In the intermediate goods sector, monopolistically competitive firms produce differentiated goods t_t , utilizing capital services, $\bar{k}_t = u_t + k_{t-1} - \pi_t^Z$, and labour in a constant elasticity of substitution production function:

$$t_t = f_{61}(l_t + z_t^L) + f_{62}\bar{k}_t, \quad (2.9)$$

where z_t^L is a labour augmenting productivity shock that temporarily increases the level of production.

The amount of capital services depends on the capital stock and the utilization rate, whereas the stock itself is determined by depreciation and investments done one period earlier. There are convex adjustment costs of changing both the level of the investment to capital ratio, $(inv_t - k_{t-1})$, and the rate of change in this ratio. Together with variable capital utilization and habit persistence, these costs make up the real rigidities in NEMO. The investment to capital ratio is thus a slowly moving variable that reacts positively to increases in the expected real return to capital, $E_t r_{t+1}^K$, and negatively to the expected real interest rate, which reduces the discounted value of returns. A somewhat simplified version of the

investment Euler equation can be written

$$\begin{aligned} inv_t - k_{t-1} = & f_{111}(inv_{t-1} - k_{t-2}) + f_{112}E_t \{inv_{t+1} - k_t\} \\ & - f_{113}E_t \{(i_t - \pi_{t+1}) - f_{114}r_{t+1}^K\} + shock_t^{inv} \end{aligned} \quad (2.10)$$

Intermediate firms set prices as a markup above the competitive price, and prices respond sluggishly to shocks due to convex adjustment costs à la Rotemberg (1982). Intermediate goods inflation, π_t^Q , increases with real marginal costs and decreases with a cost push shock represented by the substitution elasticity between the domestically produced intermediate goods, θ_t^H :

$$\pi_t^Q = \frac{\beta}{(1+\beta)}E_t\pi_{t+1}^Q + \frac{1}{(1+\beta)}\pi_{t-1}^Q + f_{131}(mc_t - p_t^Q) - f_{132}\theta_t^H \quad (2.11)$$

Prices on the exported factor inputs are set in the local currency at the destination where they are sold, and they evolve in a similar way to domestic intermediate prices. Foreign intermediate good producing firms set domestic prices in an identical way to domestic firms, so imported inflation is governed by a corresponding Phillips curve.

The real exchange rate, s_t , is governed by a version of the standard uncovered interest rate parity (UIP) condition¹. In optimum, the expected returns on domestic and foreign bonds must be equal. There is also an exogenous risk premium z_t^B , of which a positive realization means that the return to foreign bonds relative to domestic bonds increases, i.e. that foreigners demand a higher real return for a given exchange rate:

$$s_t = f_{201}E_t s_{t+1} - E_t \{i_t - \pi_{t+1}\} + E_t \{i_t^* - \pi_{t+1}^*\} + z_t^B \quad (2.12)$$

The government purchases final goods financed through a lump-sum tax, invests in the petroleum sector and sets the short term nominal interest rate. Government spending and oil investments are exogenous variables. The other exogenous variables include domestic shock processes and all the foreign variables except export prices (i.e. Norwegian import prices). These are all modelled as AR(1) processes with normally distributed white noise shocks ε_t :

$$z_t = \lambda z_{t-1} + \varepsilon_t \quad (2.13)$$

¹Note that the real exchange rate is denoted by the letter q in LGM.

The model is closed by assuming market clearing for the final good, the intermediate good, labour, and domestic bonds. I use the estimated version of NEMO that was used for the analyses in Norges Bank’s Monetary Policy Report no. 3, 2011 (Norges Bank 2011)².

2.3 Credit NEMO

Credit NEMO is an extension of the benchmark version of NEMO with a credit market explicitly modelled as a separate sector producing houses (Brubakk and Natvik 2010). It builds on the models by Kiyotaki and Moore (1997), Iacoviello (2005) and Iacoviello and Neri (2010) in which credit markets are included in otherwise standard DSGE models in order to incorporate effects from asset prices and credit constraints to the real economy. The housing sector in Credit NEMO is endogenous — in contrast to a fixed real estate amount in Iacoviello (2005) — such that housing investments and production are additional driving forces of the economy.

The housing sector in Credit NEMO uses the final good as input and has a lower productivity growth than the rest of the economy; this is consistent with the observed upward trend in the relative price of housing to other goods. All variables are detrended with their respective long run growth rates. The housing stock depreciates over time and is increased by new investments. House prices evolve according to the productivities in the housing and intermediate goods sectors, to the level of and change in the investments to housing stock ratio, and a housing investment shock. In addition to the shocks in NEMO, there are three housing shocks (to housing demand, housing productivity and the loan-to-value ratio) that contribute noticeably to the variance of endogenous variables.

Households exhibit habits in housing consumption, and the housing services enter directly into their utility function. They are divided into two groups, patient and impatient, where the latter are credit constrained and by assumption only borrow a given share of the value of their housing stock (Iacoviello 2005). This loan-to-value ratio is exogenously given and set to 0.9³. Impatient households earn labour income and borrow from the patient households. Only patient households have access to a foreign bonds market where they can borrow to finance consumption, housing services and lending to impatient households. Borrowing is in zero net supply, and the total stock of housing is divided between impatient and patient households, with shares equal to their income shares.

²In the version used for this report, some of the price setters are assumed to be completely backward looking (non-optimizing). I set this share to zero, however, as I want to use the estimated model.

³Until recently Norwegian house buyers had to self-finance minimum 10 percent of the price, such that a 90 percent loan-to-value ratio seems reasonable. The required self-finance share has been increased to 15 percent, however.

The intermediate sector is modelled as in the benchmark version of NEMO, but with two types of labour, supplied by patient and impatient workers. Total labour input is a Cobb-Douglas function of the hours worked by the two types. Intermediate firms choose prices and factor inputs in order to maximize the expected cash flow.

By relaxing the assumption of homogeneity among households and incorporating a channel from balance sheet positions to agents' decisions, Credit NEMO is able to capture a financial accelerator effect in which shocks that influence house prices are amplified and propagated through the effects on consumption and housing demand. Two mechanisms contribute to this financial accelerator: one wealth effect through higher consumption when asset prices increase, and one indirect balance sheet effect. The latter results from a higher value of the accessible credit of impatient households, which drives up their demand for housing services and consumption.

Because we want to focus on differences in how the domestic economy is modelled, we let the foreign variables in Credit NEMO develop according to the same AR(1) processes as in the benchmark version of NEMO.

2.4 LGM

2.4.1 Description of the model

The Leitemo-Gali-Monacelli (LGM) model is an open economy small scale new Keynesian DSGE model stemming from the work of Galí and Monacelli (2005) and Monacelli (2006). Our version is closer to the one developed and estimated by Leitemo (2006). It shares many features with the canonical new Keynesian model for open economies (Galí and Monacelli 2005; Galí 2008), but it includes more realistic open economy aspects by allowing for incomplete pass-through of exchange rate movements to import prices. This creates a source of frictions in addition to the standard ones in the canonical model, and it is more consistent with data (Monacelli 2006). In addition, the model allows both expected future inflation and previous periods' inflation to determine inflation and output today.

The core of the model is constituted by four equations: two Phillips curves for domestic and imported inflation, respectively, an IS curve governing output gap movements, and an equation for the real exchange rate. The domestic economy is populated by a representative agent who chooses consumption, savings and labour supply in order to maximize discounted utility given his budget constraint. There are complete international markets for state contingent assets, such that consumers in all countries can invest in the same assets. This assumption pins down the relationship between domestic consumption, foreign consumption

and the terms of trade. The household consumes an aggregate of domestic and imported goods. The domestic good is in turn an aggregate of a continuum of goods, each produced by a monopolistic firm that wants to set price as a markup over marginal costs in order to maximize current and discounted future profits. However, prices are set in the Calvo (1983) manner. This leads to some price stickiness, as firms are not able to translate marginal cost changes into price changes without a delay. In contrast to NEMO, however, there are no frictions associated with wage setting, and the wage is not explicitly modelled. There is also no final good producer; the imported and domestic goods are consumed directly by the household.

While in NEMO foreign exporters set prices for their products in Norwegian currency (local currency pricing), imported intermediary goods in LGM are priced by a separate, domestic imports sector that takes prices on the world market as given and then set the domestic price. These firms need to take into account that when prices are sluggish, exchange rate movements lead to deviations of the world price (in domestic currency units) from local market prices. This difference is called the law of one price (LOP) gap, given by

$$\begin{aligned}\psi_t^F &= e_t + p_t^* - p_t^F = e_t + p_t^* - p_t - (1 - \gamma) [p_t^F - p_t^H] \\ &= q_t - (1 - \gamma)s_t,\end{aligned}\tag{2.14}$$

where e_t is the nominal exchange rate, p_t^* is the world price in foreign currency, p_t^F is the imported goods price (in domestic currency), q_t is the real exchange rate, γ is the share of imported inflation in CPI inflation, and $s_t = p_t^F - p_t^H$ is the terms of trade. When ψ_t^F is large, inflation rises as importers seek to raise local prices in order to get them in line with the price they face in the world market. Due to price-setting frictions, the LOP gap will not be closed instantly, and this leads to incomplete short run pass-through.

In order to make the model more realistic, we do some changes to the core structure outlined above. First, we follow Leitemo (2006) in allowing for a more gradual adjustment of prices and output. This can be explained by information and implementation lags due to e.g. rule-of-thumb pricing and habit formation in consumption. We allow for four lags of inflation in the two Phillips curves and two lags of the output gap in the dynamic IS equation.

Second, we depart from Leitemo's specification of a standard UIP condition by allowing for a more gradual development of the real exchange rate. The real exchange rate depends partly on the expectations of next quarter's rate and partly on the previous quarter's rate. It follows the equation

$$q_t = (1 - \alpha)E_t q_{t+1} + \alpha q_{t-1} - \beta(i_{q,t} - E_t \pi_{q,t+1}) + (i_{q,t}^* - E_t \pi_{q,t+1}^*) + \tau_t, \quad (2.15)$$

where $i_{q,t}^*$ and $\pi_{q,t+1}^*$ are the foreign interest rate and inflation rate, respectively, τ_t is a shock, and all variables are in quarterly terms.

Third, the forward component of the Phillips curves consists of expectations of only next period's inflation rate, not the whole year ahead. This is in line with both Monacelli's (2006) specification and the canonical representation from the literature (e.g. Galí 2008). However, the decisions are subject to a one quarter implementation lag, meaning that the previous quarter's expectations of future variables determine this quarter's variables.

We calibrate the share of imported inflation in CPI inflation to $\gamma = 0.4$, which is higher than the value used by Leitemo (2006). There are two reasons for this change. First, the Norwegian economy is more open than the British, which means that imported goods constitute a larger fraction of total consumption and production. Second, the value 0.4 corresponds roughly to the share of imported intermediate goods in production of the final good in NEMO⁴.

Foreign variables — the interest rate, inflation and the output gap — are modelled as in NEMO, using estimated AR(1) processes for each variable. Since we want the foreign economy to be identical across models, we keep the parameter values for the persistence coefficients from NEMO, but estimate the standard deviation of the shocks. For estimation purposes (but not for later simulations), we close the model by specifying a simple interest rate rule that includes current inflation, the current output gap, and one lag of the interest rate.

2.4.2 Estimation

The model is estimated as a system using Bayesian methods. This allows us to incorporate prior information regarding the parameter values and in this way avoid the "absurd" values that can result from maximum likelihood estimation when the model is misspecified (An and Schorfheide 2007). By weighting the likelihood function by a prior density, information not contained in the sample used for estimation can be included in the estimation process.

The Bayesian framework means that we must specify prior probability distributions that reflect our beliefs prior to estimation about the parameters to be estimated. As prior mean values we use the estimates that Leitemo (2006) obtains with data from the United Kingdom.

⁴Furthermore, our calibration corresponds to that which Monacelli (2006) finds to be reasonable for a small open economy.

We specify normal distributions for most parameters, but use the beta distribution for those constrained to lie between zero and one. We estimate the standard deviations of eight Gaussian shocks (error terms) and use the inverse gamma — which restricts them to be positive — as the prior distribution.

The monetary policy rule is a three parameter rule that includes inflation, the output gap and the lagged interest rate. It has the form

$$i_t = \rho i_{t-1} + \phi_\pi \bar{\pi}_t + \phi_y y_t, \quad (2.16)$$

where $\bar{\pi}_t$ is the year-on-year inflation rate. The prior mean values of ϕ_π and ϕ_y in this equation are based on the standard Taylor rule, but we include a considerable degree of interest rate smoothing ($\rho = 0.75$) consistent with the stated objectives of Norges Bank (see section 3.1). The standard deviations of shocks in the AR(1) processes for foreign variables are described by the beta distribution, and the mean values are the estimated values from NEMO. We impose some linear restrictions on the parameters. First, the sum of the coefficients on forward and backward terms in the two Phillips curves and in the output equation should sum to one. Second, the sum of the effects of all the lags in the Phillips curves are also restricted to one, i.e.

$$\sum_{j=1}^4 \alpha_j = \sum_{j=1}^4 \chi_j = 1. \quad (2.17)$$

We use eight data series for the period 1993:Q4-2011:Q2, which is the period used for estimating NEMO. All data are observed at a quarterly frequency and have been obtained from Norges Bank’s Datawarehouse. The eight data series used for estimation are reported in appendix A.3, table A.1. These are for the most part the same as those used for estimation of NEMO. We transform the observable variables in a way that is consistent with the model variables being log-linearized around the steady state and that there is no long run growth in the model. To create the output gap from the series for GDP per capita, we use the Hodrick-Prescott (HP) filter with a smoothing parameter $\lambda = 16000$. This is ten times the value originally proposed and most commonly used for US quarterly data (Hodrick and Prescott 1997). The reason for choosing this value is that it creates a smoother trend and thus more volatile cycles, thought to fit the Norwegian economy better. We also use this filtering for the real exchange rate, as we find a clear downward trend in this variable throughout the data period. Such de-trending makes the observable variables consistent with the model. In

addition, all variables are demeaned prior to estimation.

The model is estimated in Dynare. First we obtain an approximation of the mode of the posterior distribution. Then we construct a Gaussian approximation of this distribution around the mode using a Metropolis-Hastings Markov Chain Monte Carlo optimization routine. The routine makes 500.000 draws from the distributions — half of which are discarded — and runs two parallel chains. We use the mean of these distributions as point estimates of the parameters. Priors and results of the estimation are reported in appendix A.3, table A.2.

2.5 NAM

The Norwegian aggregated model (NAM) is a quarterly macroeconomic model developed specifically for the Norwegian economy by Bårdsen and Nymoen (2001), Bårdsen et al. (2003), and Bårdsen (2005). The version used in this thesis is the one documented in Bårdsen and Nymoen (2009). As opposed to the other models we consider, it does not assume that the economy is a system in general equilibrium, and no forward-looking rational agents are modelled. Instead, different parts of the economy are modelled separately, relying partly on theory and partly on data to identify the relevant variables in each equation. The model is formulated in error correction form. First, starting from a general vector autoregression (VAR), cointegrating relationships between variables in levels are identified. These describe the long run steady state. Then the short run dynamic structure is estimated, using the long run relationships as error correction terms. When the system is out of equilibrium, i.e. when the long run relationships between endogenous variables do not hold, the cointegrating terms will make sure that the relevant variables move back towards their long run values. The model can be written on the form:

$$\Delta y_t = \alpha + \sum_{i=1}^j \Gamma_i y_{t-i} + \sum_{i=1}^k \Pi_i \Delta y_{t-i} + u_t, \quad (2.18)$$

where y_t is a vector of (logged) endogenous variables, α is a vector of constants, Γ_i and Π_i are parameter matrices $\forall i$, and u_t is a vector of error terms. Here the second term on the right hand side constitute the error correction parts of the equations, which in each equation describes a cointegrating relationship between the left hand side variable and a linear combination of other variables. The short run dynamics is described by lags of differenced variables.

The model consists of equations for the wage, prices, productivity, output, unemployment,

household credit, money market interest rates, and the nominal exchange rate. Wages are modelled in a Nash bargaining framework meant to capture the high degree of coordination in Norwegian wage setting. In the long run nominal wages will move one-for-one with the general price level and productivity, and it will also depend to some extent on the unemployment rate. Domestic prices are set by firms engaged in monopolistic competition. Thus the general price level will in the long run depend on wages relative to productivity, as well as imported prices. Long run equilibrium unemployment is determined by the growth of the real wage as well as the real interest rate and output. The long run behaviour of the nominal exchange rate is derived assuming that expected depreciation depends on deviations of the exchange rate from its long run value, and that there is a constant long run risk premium in the foreign exchange market. Movements in relative real interest rates do not lead to one-for-one changes in the real exchange rate, as in the standard UIP condition.

Total production is in the long run determined to a large extent by government demand, which in the original system is exogenous and will be assumed constant in our model (see below). In addition, depreciations of the real exchange rate and decreases in the real interest rate both affect output positively in the long run. In the short run, output growth is significantly affected by its own lag, changes to government expenditures and changes in real credit. The latter effect might be due to frictions in the credit market. The growth of real credit is in turn determined in the long run by the growth of output and - to a smaller extent - by interest rate differentials. Since output affects credit and *vice versa*, there is a simple financial accelerator mechanism at work. Labour productivity depends in the long run both on real wages, the unemployment rate and a linear trend. In the short run it is affected by the change in real wages.

Most of NAM is estimated equation-by-equation using OLS, but the wage and price block is estimated as a system with full information maximum likelihood. Identification of the system is achieved by means of theoretical and ad hoc overidentifying restrictions on the short run dynamics. Seasonal dummies are added for better fit. The original model's long run growth is driven by neutral technological progress, approximated by a linear trend in labour productivity. Simulations show that the model induces in steady state a constant growth rate (disregarding exogenous seasonal variations) of output, nominal wages and prices, and constant values of the unemployment rate and the nominal exchange rate (Bårdsen and Nymoén 2009: 879-883).

In order to make numerical simulations of the model tractable by making also nominal variables stationary, we remove all trends and constant terms so that all variables are zero in steady state. The original model can be viewed as a log-linearization. Under this interpretation, the variables in our modified model will be interpreted as deviations of the actual

(logged) variables from either a deterministic balanced growth path (for some variables, such as the output gap and productivity) or constant steady state values (for other variables, including the inflation rate and the unemployment rate). This corresponds roughly to the log-linearization used to make NEMO and Leitemo stationary, and we will interpret the relevant variables in the same way across models.

NAM contains several exogenous variables, namely government sector consumption; a price index for electricity, fuel and lubricants; the oil price; and the payroll tax rate. This poses a problem for our simulations. Instead of assuming dynamic processes for all these variables, we set the domestic exogenous variables equal to zero (their steady state values) in all periods. This is clearly unrealistic, and it means that the total variation in the endogenous variables will be smaller than what is observed in the data. However, we do not want to change the original model dynamics in any important ways by adding new equations, and thus this approach is the most convenient for our purposes. As for the foreign variables, we tried to model these in the same way as in NEMO, but the AR(1) process for foreign inflation created stability-problems in NAM, leading to infinite variance of several important variables, including the domestic inflation rate. For this reason, we let foreign inflation be constant, but model the foreign interest rate as in the other models. In addition, the foreign producer price index is held constant during simulations.

Because Dynare has trouble solving models in which some variables have infinite variance — which is the case for the nominal prices in NAM — we use a stationarized version when calculating optimal policy rules. In this version, growth rates of price variables and the cointegrating relationships are defined as new variables, but this transformation does not affect the structure of the model in any way that is relevant to us.

2.6 Transmission of monetary policy

We can roughly divide the "standard" transmission mechanisms of monetary policy in two: an aggregate demand channel and an expectations channel (Svensson 1999; Svensson 2000). The policy rate affects demand directly through its effect on the short term real interest rates and thus on the relative value of saving versus consuming. For the simple new Keynesian model in section 2.1.1, this is apparent in the IS equation 2.4. Demand then affects inflation via equation 2.3, as a change in output induces a change in marginal costs. The expectations channel is due to the forward-looking behaviour of agents, since expectations of future prices and output affects today's inflation and output; consumers seek to smooth consumption over time, while producers take into account future marginal costs. In an open economy, there will also be a real exchange rate channel. A higher interest rate, *ceteris paribus*, immediately

induces a real appreciation, which in turn leads to a decreased demand for domestic goods. This contributes to the aggregate demand channel. A change in the real exchange rate will also directly affect inflation as it changes the domestic currency price of imported goods.

In order to compare the responses to monetary policy in the four models, I let monetary policy be given by a simple Taylor rule (see section 3.3) with an exogenous component u_t which follows a moderately persistent AR(1) process:

$$\begin{aligned} i_t &= 1.5\bar{\pi}_t + 0.5y_t + u_t \\ u_t &= 0.5u_{t-1} + \epsilon_t, \end{aligned} \tag{2.19}$$

where $\bar{\pi}_t$ is the year-on-year inflation rate and ϵ_t is a shock.

Figure 2.2 plots the ten year (40 quarters) responses of the year-on-year inflation rate, $\bar{\pi}_t$, and the output gap, y_t , to a one percentage point one period shock to ϵ_t . The system starts from steady state. Such a shock is not necessarily realistic, but it allows us to study how monetary policy feeds through the economy.

In NEMO, due to rigidities in nominal prices, the shock causes a rise in the real interest rate. Through the demand channel, this lowers consumption and investment demand, which means that final good firms will produce less and hence use less intermediates as inputs. Consumption falls more for the spenders than for the savers, and nominal wages drop. Expected future marginal costs fall, and so there is an additional effect on inflation through the expectations channel. The short run response is muted because firms adjust their utilization rate of capital services. The exchange rate channel is at work through appreciation of the currency and downward pressure on import prices measured in domestic currency. Even though export prices increase in the short run due to a stronger domestic currency, they fall subsequently with marginal costs, which means that export demand will eventually rise. When inflation and output falls, the interest rate is lowered, leading to a gradual movement back to the steady state.

The effects are similar in Credit NEMO, but the presence of the housing sector gives an additional channel through which the monetary policy affects the economy. A higher real interest rate leads to lower house prices and thus a lower value of the housing stock. This means that impatient households can borrow less, since they have less collateral, and as a result there is an additional effect on the output gap.

In LGM, the effects of a shock to the policy rate conform closely to those in the simple model in section 2.1.1, but there is a more complicated lag structure. The combination of backward and forward terms in the inflation and output equations induce a clear hump-

shaped response in these variables, partly through the expectations channel. The exchange rate channel is at work through the law of one price gap, which decreases immediately when the real exchange rate appreciates. Importing firms then seek to close the gap by lowering domestic prices on imported goods. Compared to NEMO and Credit NEMO, the reactions of inflation and output in LGM are characterized by larger and more persistent fluctuations. This is partly because the Taylor rule is not very effective at stabilizing these variables in LGM (see section 4.3.1).

In NAM, there is both a real exchange rate channel and a demand channel of monetary policy, but not an expectations channel. The policy rate affects the economy indirectly through its effect on the bank rate. The demand channel goes through both the unemployment rate and the output gap. The immediate rise in the nominal rate increases the nominal and real exchange rate, which (with a lag) leads to a lower production level. The real exchange rate appreciates immediately, which in turn lowers the growth rate of import prices and hence also CPI inflation. The drop in inflation means that the real interest rate will rise even more than the nominal rate, and thus output falls more. There is an indirect exchange rate effect, as a stronger currency means decreased competitiveness and thus lower output and higher unemployment. In this model there is also a labour market channel of monetary policy, but it has a negligible effect on these variables. Because of the complex autoregressive processes, there are considerable short run fluctuations in both inflation and the output gap.

The lack of an expectations channel in NAM separates it from the other models. When agents are optimizing and forward-looking, they will take into account how monetary policy is expected to be conducted in the future. Thus the short run responses in the endogenous variables will depend on how the policy rule is specified in NEMO, Credit NEMO and LGM, but not in NAM.

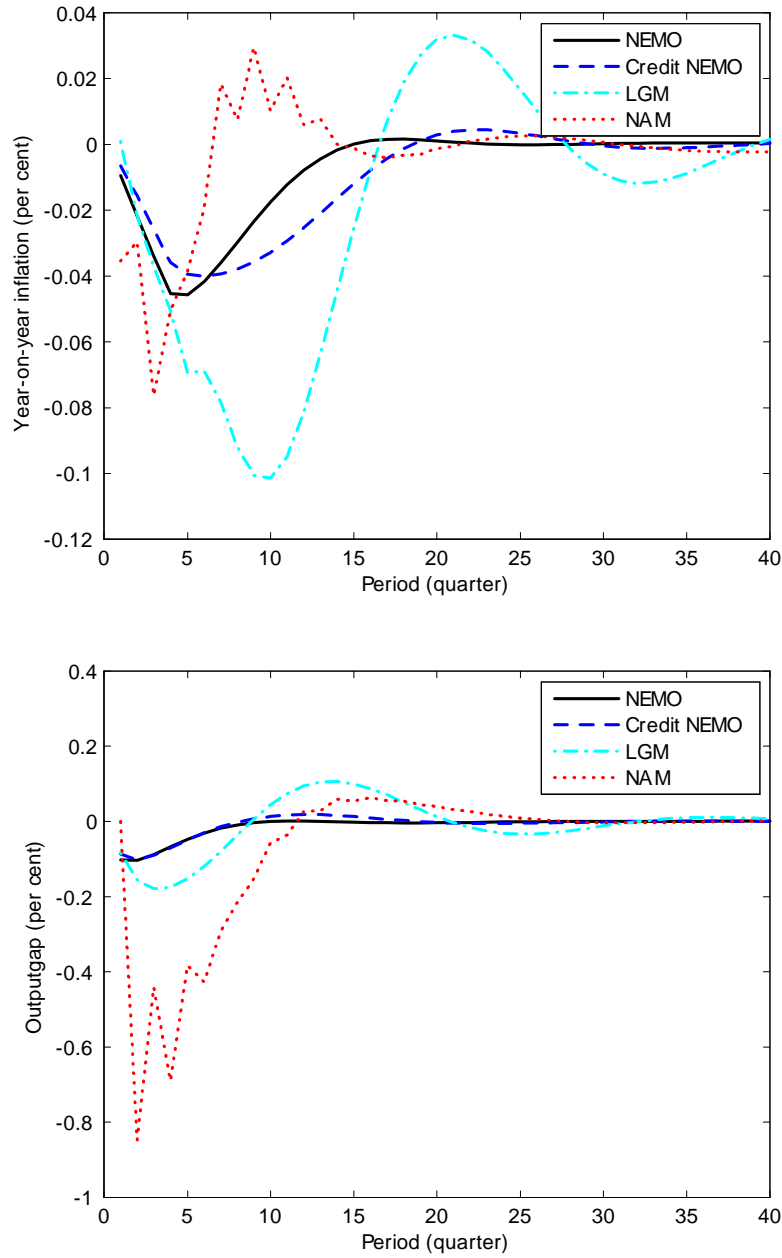

Figure 2.2: The responses of year-on-year inflation (upper panel) and the output gap (lower panel) to a moderately persistent one percentage point initial shock to the policy rate. Monetary policy follows the Taylor rule. The numbers on the horizontal axis are quarters after initial impact.

Chapter 3

Theoretical background: optimal policy, simple rules, and robustness

3.1 Social welfare and the loss function

Most central banks today operate a monetary policy regime that is called inflation targeting. According to Bernanke and Mishkin (1997), "the hallmark of inflation targeting is the announcement by the government, the central bank, or some combination of the two that in the future the central bank will strive to hold inflation at or near some numerically specified level." In Norway, this level is 2.5% for the annual consumer price inflation (Finansdepartementet 2001). Most central banks also make room for other, secondary objectives, such as stabilization of the output gap or the exchange rate. There is today a general agreement both in policy circles and in the literature that stabilization of inflation around some target and output around some trend should be the main — and possibly the only — goals of monetary policy (Woodford 2003: 382). Such a regime is generally referred to as *flexible* inflation targeting, and it is in this context I analyze monetary policy in this thesis.

Bernanke and Mishkin (1997) point to several theoretical developments that played a role in ushering in the inflation targeting regimes, namely "reduced confidence in activist, countercyclical monetary policy; the widespread acceptance of the view that there is no long run trade-off between output (or unemployment) and inflation, so that monetary policy affects only prices in the long run; theoretical arguments for the value of precommitment and credibility in monetary policy [...]; and an increasing acceptance of the proposition that low inflation promotes long run economic growth and efficiency." As I have discussed in section 2.1, the lack of a long run trade-off is grounded in the new Keynesian modelling tradition. The issue of precommitment is discussed in section 3.2.1. In the present section I show why (flexible) inflation targeting is generally accepted as best practice monetary policy, and how

it can be expressed by means of a welfare loss function.

A welfare loss function can either be derived from fundamentals using a complete micro-founded model of the economy, or it can be chosen in a more ad hoc manner. In any case, the standard expected loss function is quadratic and can be written on the following general form:

$$L = E_0 \sum_{t=0}^{\infty} \beta^t Y_t^T \Lambda Y_t, \quad (3.1)$$

where Y_t is a column vector of variables (called the *target variables*) at time t , Λ is a quadratic form and β is a discount factor. For the most part, Λ is a diagonal matrix, so that each period's contribution to the loss function consists of a weighted sum of squared variables.

It turns out that only a small set of variables need to be included in the vector Y_t in equation 3.1 when the loss is derived from fundamentals. Starting from simple New-Keynesian models similar to the one presented in section 2.1.1, Galí (2008: 86-89) and Woodford (2003: ch. 6) derive a function for the expected welfare loss expressed as a fraction of steady state consumption level:

$$L = -E_0 \sum_{t=0}^{\infty} \beta^t \left(\frac{U_t - U}{U_c C} \right) = E_0 \sum_{t=0}^{\infty} \beta^t L_t^p, \quad (3.2)$$

where U_t is period t utility, U is steady state utility, and C is steady state consumption. L_t^p is the period loss, which is given by

$$L_t^p = \lambda_{\pi} \pi_t^2 + \lambda_y y_t^2, \quad (3.3)$$

where λ_{π} and λ_y are constants that depend on the parameters of the model.

In these simple models with optimizing agents and sticky prices, expected welfare decreases with the square of the deviation of inflation from the optimal inflation rate, which I have assumed is zero, and the square of the gap between output and the natural level of output. This is derived assuming that utility depends only on consumption and labour supply. Furthermore, it is assumed that the steady state flexible price equilibrium is an efficient one¹.

¹Galí (2008) assumes that steady state distortions due to e.g. monopolistic price setting can be offset using fiscal policy.

A fluctuating output gap means that the average markup over marginal costs in the economy will fluctuate. When prices are rigid, this implies that the use of labour in production will be inefficient. Thus it is optimal to stabilize the output gap in order to stabilize the average markup. Even though price changes are not directly associated with welfare, they will have an indirect effect: since not all prices change at the same time, a non-zero inflation rate implies relative price distortions that result in deadweight losses due to an inefficient composition of production (Woodford 2003: 383). For example, when inflation is positive, firms that have not re-optimized in a long time sell at lower prices than their competitors and will thus produce more than they should for an efficient allocation. Perfect price stability will then eliminate all incentives for firms to change prices even when they are allowed to, and so this situation is similar to the one with perfect price flexibility.

Incorporating the interest rate into the loss function can also be motivated from micro-behaviour. Woodford (2003: 420-424) shows how the square of the deviation of the interest rate from its steady state value enters the period loss once transaction frictions are considered and real money balances are included in the utility function. Williams (2003) adopts a similar constraint on interest rate variability for more ad hoc reasons, one of which is that a highly volatile short term rate might lead to higher long term rates through a higher term premium. Another practical reason for placing some weight on this term is that when it is left out, the optimal policy might be so aggressive that the nominal interest rate will often hit the zero lower bound (Levin, Wieland, and Williams 1999). Since variation in the change in the interest rate from period to period seem in practice to matter more for policymakers than does variations in the rate itself, Ilbas et al. (2012), Levin and Williams (2003) and Orphanides and Williams (2008) substitute $\Delta i_t = (i_t - i_{t-1})$ for i_t .

Issues that are specific to open economies might present other problems. In particular, these might be related to fluctuations in the real exchange rate and the relative prices between the domestic economy and the foreign economy. Clarida et al. (2001) finds that the open economy loss function is the same as for the closed economy counterpart when there is complete pass-through of real exchange rate fluctuations to the domestic economy². Corsetti et al. (2010) allow for incomplete pass-through along the lines of the LGM model (see section 2.4). They find that also the law-of-one-price gap, reflecting the difference between the domestic price and the world price of the same good, must be added to the loss function in this case.

The loss function I employ for welfare analysis in this thesis is not directly derived from any single model, although it is based on the theoretical considerations above. It has the

²The only difference is that the domestic inflation rate should enter the loss function instead of the aggregate rate. I disregard this point in order to stay closer to the actual loss function used by Norges Bank.

following functional form:

$$L = E_0 \sum_{t=0}^{\infty} \beta^t \{ \bar{\pi}_t^2 + \lambda_y y_t^2 + \lambda_{\Delta i} (i_t - i_{t-1})^2 \}, \quad (3.4)$$

where $\bar{\pi}_t$ is the year-on-year inflation rate³. Written on this form, the weight on fluctuations in the inflation rate is for simplicity normalized to one, since we are in any case not interested in the absolute value of the loss.

There are several reasons why an ad hoc loss function is preferred to one derived from fundamentals. First, the models employed might be either insufficiently micro founded or too complex for a true welfare function to be derived (Ilbas, Røisland, and Sveen 2012). The former holds for NAM and LGM, while the latter applies to NEMO and Credit NEMO. Second, commonly used models do not capture all of the costs due to fluctuations in the economy (Clarida, Gali, and Gertler 1999), and thus it is necessary to use some extra-model judgement when deciding on the objectives. Third, at least parts of the objectives are usually given to the central bank by law and are therefore outside of its control.

Equation 3.4 corresponds to the specification used by Norges Bank as an operationalization of the flexible inflation targeting mandate and the preferences of the policymaker (Holmsen et al. 2008). The Bank has outlined a set of criteria by which its interest rate setting can be assessed (Qvigstad 2006; Norges Bank 2012). First, inflation should be stabilized around target in the medium term. Second, there should be some balance between stabilization of inflation around target and output around the trend. Third, the interest rate should be changed gradually and in a way that is consistent with the previous response pattern⁴. These three criteria can be represented by the three terms in equation 3.4. This specification of the loss does not take into account the specific open economy issues discussed above, since these are not explicitly part of the stated criteria or the loss function used by Norges Bank. I assume that volatility of the exchange rate is only important to the extent that it affects the volatility of inflation or the output gap.

There is little consensus in the literature on the size of the weights in the loss function (Levin and Williams 2003; Cateau 2007). This is true even when the loss function is derived from fundamentals. For example, λ_y is very sensitive to what kind of stickiness in prices that is assumed; while Calvo pricing decisions typically lead to a very low weight on output

³The choice between the year-on-year rate and the quarterly annualized rate is not clear-cut. However, the year-on-year rate seems to correspond more closely to Norges Bank's mandate. The (approximate) relationship between the quarterly annualized rate π_t and the year-on-year rate $\bar{\pi}_t$ is: $\bar{\pi}_t = \frac{1}{4}(\pi_t + \pi_{t-1} + \pi_{t-2} + \pi_{t-3})$.

⁴In addition, a robustness criterion is given. I leave this for later discussion.

stabilization ($\lambda_y \approx 0.01$), Taylor-type fixed duration contracts typically give a much higher weight ($\lambda_y \approx 1$). Similarly, while Svensson (2003) argues that it is difficult to motivate theoretically a weight on interest rate stabilization, estimation show that this is needed to match actual policy (Cateau 2007). In actual policymaking, however, the weights are rarely chosen based on a theoretical derivation from a single model.

For simulation purposes, it is convenient to express the loss function in a different form than equation 3.4. As shown by Rudebusch and Svensson (1999), for $0 < \beta \leq 1$ we can express the intertemporal loss function as the unconditional mean of the period loss function. Since the unconditional mean of each of the target variables is zero, the loss function is then written

$$L = Var[\bar{\pi}_t] + \lambda_y Var[y_t] + \lambda_i Var[i_t - i_{t-1}], \quad (3.5)$$

where I have multiplied the loss by $(1 - \beta)$ as a normalization, since only relative changes in the size of the loss is important in my analysis. Thus the relevant loss criterium is the weighted average of the unconditional variances.

3.2 Optimal policy

I denote by *optimal policy* the policy that uses all available information — contained in exogenous and endogenous variables — in order to minimize a specified loss function. This involves solving an optimization problem in which the objective is the loss function and the structural equations of one's model appear as constraints. There are several ways to describe such an optimal policy; the instrument can be specified as a function of exogenous disturbances, or in terms of projected or past values of endogenous variables.

3.2.1 Rules versus discretion

A classic distinction in the monetary policy literature is that between the optimal discretionary solution and the optimal policy when commitment to follow a rule is possible. In the former case, the policymaker sets the interest rate every period by solving a new optimization problem under no constraints resulting from previous commitment. Knowing that he will re-optimize next period — and knowing that the private sector knows this — he takes private sector expectations of future variables as given. This is because these expectations are not affected by the current interest rate. As shown first by Kydland and Prescott (1977), when the policymaker is unable to commit, the promise of a certain path for the instrument is time

inconsistent; it is optimal to renege on the plan and re-optimize next period, and the private sector knows this.

When solving a commitment problem, however, the central bank chooses conditions that will hold in any future period, and thus its choice of policy will affect expectations of the future. It is the binding commitment to a future reaction function that makes the policy credible and thus steers expectations. When expectations of the future affects today's equilibrium, the possibility of manipulating these expectations using policy means that the central bank can bring about a better outcome than under discretion. The discretionary policymaker fails to internalize the consequences of people's anticipation of his own future conduct. More specifically, there are two separate problems with discretionary optimization. First, there is a possible positive bias in the average inflation rate when the policymaker tries to push output above its potential level by exploiting the short run trade-off between inflation and output (Kydland and Prescott 1977; Barro and Gordon 1983). Second, the discretionary policymaker's reaction to shocks will in general be inefficient and for this reason lead to larger welfare losses than when commitment is possible (Woodford 2003; Clarida et al. 1999).

In most cases, then, the equilibrium and the reactions to disturbances that can be achieved by a committed policymaker dominate those achievable by one who reoptimize every period⁵. For this reason, commitment to some type of rule is my starting point when considering optimal policy in this thesis. Clearly, full commitment is not achievable in practice; every central bank will at least be open to changing the weights in the loss function and details in the reference model, and the public knows this. However, clear commitment to a target inflation rate in the medium term and regular publication of forecasts of inflation, output and the interest rate path, as monetary policy is practiced in Norway, entails commitment to a large extent. Holmsen et al. (2008) document that Norges Bank's communication of policy intentions is fairly effective at stabilizing private sector expectations. In addition, it seems reasonable to assume that Norges Bank does not try to push output above its potential level. In any case, I assume in the following that the central bank has access to some "commitment technology" that makes commitment to a rule in an infinite perspective possible.

3.2.2 Optimal commitment policy: targeting rules and direct instrument rules

As an illustration of how optimal commitment policy is calculated, consider the case when the quadratic loss function only includes inflation and the output gap, and the economy is

⁵Dennis (2010) finds that when the commitment policy is calculated in a timeless perspective, in Woodford's (2003) sense, the discretionary solution is in some cases preferred.

described by the simple new Keynesian model from section 2.1.1. Then the Lagrangian of the optimization problem is written

$$E_0 \sum_{t=0}^{\infty} \beta^t \{ \pi_t^2 + \lambda_y y_t^2 + \gamma_t [\pi_t - \kappa y_t - \beta \pi_{t+1}] \}. \quad (3.6)$$

The IS equation is omitted because it has no impact on the problem in this case. The first-order conditions are given by

$$\begin{aligned} E_0 \{ 2\pi_t + \gamma_t - \gamma_{t-1} \} &= 0 \\ E_0 \{ 2\lambda_y y_t - \gamma_t \kappa \} &= 0. \end{aligned} \quad (3.7)$$

These conditions must hold for every state of the world at each date $t \geq 0$. In addition, we need an initial condition on the Lagrange multiplier, $\gamma_{-1} = 0^6$.

There are several ways to proceed from here in order to implement the optimal policy. Svensson (2003) argues in favour of what he calls *targeting rules*, of which he makes a distinction between the *general* and the *specific* sort. The former specifies only the general objectives of policy, which involves identification of the target variables (e.g. inflation and the output gap), the target values for these variables, and the loss function to be minimized. This procedure allows for the use of judgement in the decision process, since it is not specified how the forecasts of the target variables in equation 3.7 should be calculated. A specific targeting rule, on the other hand, amounts to a list of the first-order conditions from the optimization problem, and thus to the use of a specific model. Since we have no interest in the Lagrange multiplier in itself, we can simplify the conditions above into a single one that relates inflation to the output gap in every period $t \geq 1$,

$$E_0 \left\{ \pi_t + \frac{\lambda_y}{\kappa} (y_t - y_{t-1}) \right\} = 0. \quad (3.8)$$

This relation between the inflation rate and the growth rate of the output gap must be projected at time zero to hold for every future period. As shown by Woodford (2003: 523), a commitment to this relationship ensures — under quite general conditions — a unique equilibrium that corresponds to the one solving the first-order conditions above. This

⁶Woodford (2003) argues that the multiplier(s) should be set in such a way that there is nothing to gain in period zero from re-optimizing. In this way the policy will be optimal in a "timeless perspective", and it will be time consistent. For simplicity I do not consider this approach here.

specific targeting rule makes no reference to either the policy instrument or the exogenous disturbances.

McCallum and Nelson (2005) argues that Svensson's suggestion of specifying monetary policy only through a relationship between certain target variables falls short of what can be considered a monetary policy rule, since there is no reference to the interest rate. Another way to specify optimal policy involves solving the system of first-order conditions and constraint(s) in order to get unique bounded solutions of π_t and y_t in every period in terms of the expected shocks at different horizons (Woodford 2003: 488-490). These are the optimal state-contingent paths of the target variables. In general, any variable at any time will depend on the whole history of shocks as well as expected shocks at all future dates. We can then substitute for π_t and y_t in the IS equation to solve for the *state-contingent* path of the policy rate that will implement the optimal equilibrium.

A problem with this solution, however, is that it is not implementable, since the values of the shocks are not directly observable. Thus it is more interesting to look for rules that involve only endogenous variables, and, more precisely, only the observed and projected paths of the *target* variables. Such rules are what Woodford (2003: 547) call direct instrument rules. Following Svensson (1999), I define an *instrument rule* to be a rule that expresses the interest rate as a function of one or more variables. The rule is *explicit* if the instrument is a function of only predetermined variables (this might include lags), and it is *implicit* if it is a function also of non-predetermined variables. The implicitness comes from the fact that when non-predetermined variables such as expected inflation is present, the actual interest rate is only determined in equilibrium. For example, whereas last period's inflation rate π_{t-1} is readily observable when the interest rate i_t is set, the value of the expected rate next period, $E_t\pi_{t+1}$, depends on which policy is in place, since this policy affects today's expectations. Thus if the interest rate reacts to the expected inflation rate, the effective policy rate is determined together with the other variables as an equilibrium condition. For an implicit rule to be well-defined, it must — given the other equations of the model — be consistent with a determinate solution for the implied path of the instrument (Woodford 2003: 544-545).

When the structural model can be written on the form of equation 2.5 and the loss function as equation 3.4, Woodford (2003: 550-556) and Giannoni and Woodford (2003) show that it is possible to implement the optimal state-contingent equilibrium with an implicit direct instrument rule. As time t forecasts of future variables can be expressed in terms of variables observed at time t , it is also possible to write this optimal rule as an explicit one, but in that case the policy rate will depend also on other variables than those included in the loss function.

3.3 Simple rules

Roughly speaking, a *simple* interest rate rule is a guide for interest rate setting that is based only on a small amount of the information that is available to the policymaker; that is, it is an instrument rule with only a small number of arguments⁷. One of the simplest and most commonly known rules is the one proposed by Taylor (1993) and subsequently referred to as the Taylor rule:

$$i_t = \bar{i} + 1.5(\bar{\pi}_t - \pi^*) + 0.5y_t, \quad (3.9)$$

where \bar{i} is the long term (average) interest rate and π^* is the annual target inflation rate (2.5% in Norway)⁸. Although the exact coefficients in front of inflation and the output gap are not optimized in any way, this rule was chosen by Taylor because it has some of the general properties of rules found to perform well. It has two important characteristics (Taylor and Williams 2010). First, the real interest rate rises in response to an increase in inflation. This is generally a requirement for stability in most DSGE models, since a failure to adjust the rate in this way can lead to self-fulfilling expectations of higher inflation (Galí 2008). Second, it "leans against the wind", meaning that it speeds up the progress back to the long run equilibrium when the economy is hit by a shock. The Taylor rule can mimic the actual path of the policy rate in the USA (Taylor 1993), and it performs quite well in several models not available when the rule was first proposed (Taylor 1999). For these reasons, the Taylor rule is a natural starting point when discussing robustness.

Even though a simple contemporaneous rule like the Taylor rule might fit the data reasonably well, a more dynamic specification is often preferred. One way to get some partial adjustment of the interest rate is to include the lag of the rate itself in the rule, so that, *ceteris paribus*, the change from period to period will be smaller⁹. As noted by Clarida et al. (2000), there is in fact evidence of a tendency for central banks to smooth interest rates. Woodford (2003) shows that some degree of interest rate smoothing is necessary to implement the optimum in models with forward-looking agents. The reason is that inertia implies a degree of commitment to future rates, and this might reassure the agents. Another way to implement some history dependence in monetary policy decisions is to include lagged target

⁷Galí (2008) uses two more specific criteria, namely that a simple rule should only depend on observable variables and not require any precise knowledge of the exact model.

⁸Since in most models both π_t and y_t are non-predetermined at t , this rule is actually *implicit*; there is for example feedback from the interest rate to inflation intra-period. I will nevertheless treat instrument rules that contain information at time t as explicit rules (see also section 4.1).

⁹I refer to this aspect as either interest rate smoothing, inertia or history dependence.

variables, e.g. by substituting π_t by π_{t-1} . If information about the current inflation rate is not available when the central bank makes its decision, this might be a more reasonable description of policy (McCallum 1999). In addition, using both contemporary and lagged information might improve the performance of the rule (see section 4.1).

Yet another modification of the Taylor rule is to allow for reaction to expected future variables. Clarida et al. (2000) propose rules of the form

$$i_t = \bar{i} + \rho i_{t-1} + \phi_\pi (E_t [\pi_{t,t+k}] - \pi^*) + \phi_y E_t [y_{t,t+q}], \quad (3.10)$$

where ρ , ϕ_π and ϕ_y are reaction coefficients, $\pi_{t,t+k}$ is the annualized inflation rate between period t and $t+k$, and $y_{t,t+q}$ is the average output gap between periods t and $t+q$. This is obviously an implicit instrument rule, since the expectations of future variables is conditioned on the information available at t that is relevant for these variables, including the current interest rate.

Other variables might also be included in the instrument rule. In a small, open economy such as that of Norway, a natural suggestion is the exchange rate (either nominal or real). There is, however, quite a lot of disagreement about whether this is a good idea — at least when the exchange rate is not included in the loss function. While Ball (1999) finds that including the real exchange rate improves the performance of a simple rule dramatically, both Taylor (2001) and Batini et al. (2003) find only a marginal effect.

An *optimized simple instrument rule* is a rule within a certain class in which the parameters have been chosen to minimize a loss function. For example, let the class of Taylor-type rules be given by

$$i_t = \phi_\pi \bar{\pi}_t + \phi_y y_t, \quad (3.11)$$

where ϕ_π and ϕ_y are general parameters, and the steady-state and target values of all variables are assumed to be zero (as they are in the models I use). The optimal rule within this class is found by choosing the parameter values that minimize the loss function given the model equations. For complicated models like the ones I consider in this thesis, a numerical search algorithm is employed to optimize over the parameters in the rule in order to find the best combination. Depending on the model, the optimized simple rule may yield losses close to or far away from what is the case under the fully optimal policy.

3.3.1 Optimal policy versus simple rules

There is an extensive discussion in the literature on the relative virtues of simple rules and optimal policy. An obvious advantage of the former lie in their simplicity: they are easy to communicate to the private sector, and it is easy for outside observers to verify that the central bank does its job if it has committed itself to follow such a rule. At any point in time, anyone familiar with simple arithmetic can check whether the policy rate is at the level implied by the simple rule. However, as pointed out by Svensson (2003), no central bank has ever committed itself to following a simple rule. And according to Svensson there is a good reason for this: any simple instrument rule will only take into account a limited amount of information, and in many cases this will be quite restrictive on the degree to which the central bank is able to stabilize the economy. In cases when the scope of action is limited by the rule, it is unlikely that the policymaker will stick mechanically to it.

For this reason, Svensson argues that the only realistic and sensible use of simple rules is as "guidelines" or "benchmarks" in a more complex policy making process. Taylor (1993) advocated such an approach when he introduced his rule: "There will be episodes where monetary policy will need to be adjusted to deal with special factors." But according to Svensson (2003) "there are no rules for when deviations from the instrument rule are appropriate". Thus there is a problem of implementation, as the idea of a guideline is "too vague to be operational". Svensson advocates instead the use of optimal policy implemented through targeting rules, which allows for using all available information — both from within and outside of a model — in order to forecast the target variables.

McCallum and Nelson (2005), on the other hand, point out that the Taylor-type rules that are Svensson's main culprits do not comprise the entire class of simple instrument rules, and that when other types of information than contemporary inflation and output is allowed to enter the rule, it can in fact perform quite well. Taylor and Williams (2010) argue that the informational advantage that optimal policy has over simple rules is in fact quite small in most models. When we allow for simple rules that are optimized, this is especially evident. Even in a large scale models such as the Federal Reserve Board's FRB/US model, Williams (2003) finds that an optimized three parameter rule that includes the lagged interest rate does not perform much worse than the fully optimal policy. The reason is that other variables are highly correlated with the ones included in the rule, and consequently the additional information they provide is small. The conclusion seems to be that although simple rules with fixed parameters, such as the Taylor rule, might be far from optimal in a given model, an optimized simple rule will still be able to approximate the fully optimal policy fairly well.

Furthermore, the policy that is fully optimal in one model might perform worse than a simple rule in another. That is, simple rules might be more robust to model uncertainty than

more complex policies (Levin et al. 2005). This is the subject of the next section.

3.4 Robust monetary policy

The basic idea behind robustness of monetary policy is that the interest rate should be set in a way that leads to acceptable results for several possible specifications of how the economy functions. That is, even if the policymaker believes in a model that is wrong along some dimension, the policy he employs should not lead to disaster. The reason why this is desired is summed up succinctly by Bennett McCallum:

Because there is a great deal of professional disagreement as to the proper specification of a structural macroeconomic model, it seems likely to be more fruitful to strive to design a policy rule that works reasonably well in a variety of plausible quantitative models, rather than to derive a rule that is optimal in any one particular model. (Cited in Hansen and Sargent 2003)

Several studies have found that optimal policy in a single model — either the fully optimal type or an optimized simple rule in cases where such a rule provides a good approximation — might have bad stabilization properties when there is uncertainty about the true model of the economy (see e.g. Levin et al. 1999 and Levin and Williams 2003). Which model specifications are considered "plausible", what kind of uncertainty is considered, and which types of policies are advocated as robust ones vary considerably in the literature, however.

Levin et al. (2005) distinguish between three aspects, or levels, of model uncertainty. First, there might be innovation uncertainty in that the type and nature of shocks hitting the economy is unknown. Second, there is generally also uncertainty about the sizes of parameter values in the preferred model. Third, there is specification uncertainty when it comes to central structural features of the model, such as the nature of price-setting. We can also make a distinction between two ways of treating the policymaker's preferences. One way is to specify, within a Bayesian decision making framework, probabilities on each of the elements in the set of possible outcomes or models. The second way is to refuse to specify any probabilities and instead only focus on the worst possible outcome. In the following I present a brief and limited surveys of how these kinds of uncertainty and preferences are treated in the literature.

3.4.1 Robust control

The robust control framework developed by Hansen and Sargent (2008) has been very influential for the way robustness to model uncertainty is treated, also in the monetary policy

literature. This approach takes as given some linear reference model and considers uncertainty around this model. More specifically, the reference model is surrounded by a continuum of unspecified models that depart from it in that they contain additive specification errors (Hansen and Sargent 2010). Thus this is a kind of innovation uncertainty. The policymaker is assumed to be uncertainty averse, which means that he prefers to know the probabilities of different models rather than having to form subjective probabilities over them¹⁰. Gilboa and Schmeidler (1989) propose an explanation and axiomatization of such behaviour: the policymaker has too little information to form a subjective (prior) distribution over the possible models, and instead he considers a several possible probabilities on each model. When making a decision, he takes into account the largest expected loss over all models in the set; that is, he only cares about the worst case outcome. Hansen and Sargent model this as a game with two participants: an "evil agent" — representing the uncertainty — chooses additive terms to the reference model in order to maximize the expected loss, while the policymaker chooses a policy to minimize this loss. The evil agent is given a "budget" that constrains how far away from the reference model the worst case model can lie and which corresponds to the set of subjective prior beliefs over the models. Thus, the idea is to minimize the worst case outcome within a set of outcomes that are practically indistinguishable from the reference model.

Leitemo and Söderström (2008) use the Hansen-Sargent framework to calculate a state-contingent optimal policy in a small open economy model. They find that an increase in the "preference for robustness" makes policy respond more cautiously to some shocks and more aggressively to other. Onatski and Stock (2002) analyze uncertainty concerning the additive shocks in a simple backward-looking model. Giannoni (2002) builds on the same framework in order to consider uncertainty about the parameter values in a simple new Keynesian model when the instrument rule is constrained to be of the form of equation 3.11. He finds that the robust policy should react stronger to inflation than the optimal policy of this type in the reference model. Brock and Durlauf (2005) construct a general framework to analyze robustness to parameter uncertainty when the possible parameter values can lie in a ball around the reference values. These papers all consider only the worst case outcome when finding optimal policy.

There are two problems with this approach. First, it is not obvious that guarding only against the worst possible outcome is the best way to model the preferences of the policymaker. He might not have much belief at all in the worst case model. Moreover, it is not even clear that actual policymakers are unable and/or unwilling to specify single prior beliefs on the various models, and even when they are, the minmax criterium is not the only possible

¹⁰This kind of aversion is related to the so-called Ellsberg paradox (Ellsberg 1961).

operationalization of his preferences. An alternative is to specify beliefs over different models, and then minimize the weighted loss. Levin et al. (2005) calculate the expected loss in a small scale new Keynesian model when there is uncertainty about parameter values, using the posterior distributions of the parameters from a Bayesian estimation of the model. In this way, more weight is given to model variants that have a higher posterior density, and so the resulting policy is one that performs reasonably well in the models that are more likely to be relevant.

Second, it might be misleading to consider only alternative models that differ from the reference in terms of additive disturbances or the size of parameters, while keeping the structural properties of the model fixed. There is considerable uncertainty and discussion in the literature about such fundamental aspects as the nature of wage- and price-setting and expectations formation, and this specification uncertainty might be more important for policy making than relatively small differences in parameter values. Levin and Williams (2003) reveal some of the pitfalls of the robust control approach. They find that properties of the robust rules found by Onatski and Stock (2002) and Giannoni (2002) make them perform badly in alternative models. Levin et al. (2005) show that a rule that is nearly optimal for the reference model they employ is robust to changes to parameter values and some shock processes, but not to changes to more fundamental aspects of the model, such as the nature of price-setting. Furthermore, the fully optimal policy from one model can also generate huge losses in others, and even lead to instability. Thus, to the extent that we have any doubt at all about the structural properties of our reference model, the robust control framework seems insufficient for robustness analyses.

3.4.2 Robust simple rules in non-nested models

An alternative approach (Levin et al. 1999; Levin and Williams 2003; Brock et al. 2007; Taylor and Williams 2010) is to consider several models with in some cases very different structural properties. This corresponds to the third kind of model uncertainty outlined above. The models are called "non-nested", since the alternative models are not special cases of a general reference model. They can range from simple, completely forward-looking models, via more complicated new Keynesian models, to completely backward-looking models such as the one constructed by Rudebusch and Svensson (1999).

The endeavour to evaluate simple instrument rules using several non-nested models dates back at least to McCallum (1988), who simulate a monetary base growth rule in both non-structural vector autoregressions (VARs), an RBC model and structural models with nominal frictions. A somewhat different approach is to find rules that in some sense are optimized for the set of models at hand. Levin and Williams (2003) calculate both rules that minimize an

average of the losses from all the models and rules that minimize the maximum loss. If the subjective probability that model m in the countable set M is the correct one is p_m , and the policy r is chosen from the set R of possible (simple) rules, these optimization problems are, respectively, given by

$$\min_{r \in R} \sum_{m \in M} p_m L_m \tag{3.12}$$

and

$$\min_{r \in R} \max_{m \in M} \{L_m\}, \tag{3.13}$$

where L_m is the loss in model m . The first I will call the Bayesian criterion, and the second the minmax criterion.

The probabilities in equation (3.12) can either be chosen in an ad hoc way using extraneous information (Levin and Williams 2003)¹¹ or updated using Bayes' law after evaluating the likelihood function of the model given the observed data (Levin et al. 2005; Brock et al. 2003). Cogley et al. (2011) calculate Bayesian rules in this way when there is uncertainty both about type of model and about the parameter values in each model. Brock and Durlauf (2005) argue that the minmax criterion is most appropriate when the model space is constituted only of models that are fairly close to the reference model, as is the case in Hansen and Sargent's robust control framework. If the models have very different structural properties, models that are highly improbable might dominate the selection of policy, since only the model with the highest loss is considered. Still, the minmax criterion can be useful in conjunction with the Bayesian criterion, and the two might even be combined in one single criterion (see section 4.3.1).

3.4.3 Robustifying optimal policy

As pointed out in section 3.3.1, a problem with this approach is that complete commitment to a simple rule — even one that is robust to model misspecification — is unrealistic. However, the lack of robustness of fully optimal policy makes it problematic when there is some uncertainty about the "true" model. Ilbas et al. (2012) propose an intermediate way between

¹¹To call this approach "Bayesian" involves a slight misuse of terminology, since no actual Bayesian updating (using Bayes' theorem) is involved. It might be more aptly named "model averaging" (Brock, Durlauf, and West 2003). However, since the term Bayesian is used also when the probabilities are fixed in most of the robustness literature, I will do so in this thesis.

these two extremes. They formulate a modified loss function of the form

$$L^{\text{mod}} = E_0 \sum_{t=0}^{\infty} \beta^t \{ (1 - \theta) [\bar{\pi}_t^2 + \lambda_y y_t^2 + \lambda_{\Delta i} (i_t - i_{t-1})^2] + \theta (i_t - i_t^s)^2 \}, \quad (3.14)$$

where i_t^s is the interest rate given by some simple rule and $\theta \in [0, 1]$ is the weight on the deviation of the actual rate i_t from i_t^s . This loss function operationalizes the policymaker's aversion to straying too far away from the simple rule. Given a reference model, the chosen policy is the one that minimizes the modified loss function. L^{mod} should not be seen as the true welfare loss, but rather as a means for "robustifying" optimal policy. Put another way, we calculate optimal policy with cross-checking from a simple rule (Ilbas et al. 2012). In this way, simple rules can potentially be used as guidelines in a way that is completely transparent and avoids the problems pointed out by Svensson (2003).

The reasoning behind this kind of robustness check for a central bank might go something like the following. I assume that the policymaker has access to a reference model of the economy. This model is the one he sees as most likely to be a correct representation of the relevant aspects of the economy of all the models that are available to him. However, he still has some doubt about this model, and therefore he wants to consider also several other models, some of which have very different properties from the reference. If it turns out that the optimal policy in the reference model will lead to unwanted fluctuations should one of the other models be correct, the policymaker needs some way to make the policy robust. One way to do this might be to calculate optimal policy in the reference model when deviations from a simple, robust rule are given some weight in the objective function.

The idea of using such a modified loss function is similar to the idea of delegating policy making to a conservative central banker when commitment is not possible (Rogoff 1985). In that case, a discretionary policymaker who places a higher relative weight on inflation stabilization than what is given by the true social loss function will implement a better policy in terms of the true loss. Similarly, a policymaker who uses the modified loss function given by equation 3.14 when calculating the optimal commitment policy will implement a policy that is more robust to model uncertainty in terms of the original loss. Thus, it might be optimal to appoint a central banker who uses a simple rule as a guideline and correction to optimal policy. Alternatively, we can think of a policy making committee where the members have different beliefs about which model describes the economy best. The modified loss function is then a way to summarize these different preferences and beliefs in a single objective that everyone can agree on.

My approach to robust monetary policy differs in several respects from that found in other

papers. First, in contrast to the robust control literature, I use only a small set of models, but these models have very different structural properties. The inclusion of NAM makes them even more different than the ones used by Levin et al. (1999) and Levin and Williams (2003). Second, I consider only uncertainty between different models, not uncertainty about the internal mechanisms of each model, such as shocks and parameters. Third, while Ilbas et al. (2012) use American models, my models are all estimated on Norwegian data¹². Furthermore, NEMO is in regular use in Norges Bank, and an extended version of NAM, SMM, is also used for policy analysis. Using these models thus makes the analysis more relevant for actual policy making in small, open economies in general, and for Norway in particular.

¹²Akram and Nymoen (2009) investigate robustness properties of policy rules when the suite of models consists of Norwegian models similar to NAM but with different supply side features.

Chapter 4

Results

4.1 Optimal implementable policy in NEMO

For the optimal state-contingent policy from NEMO to be implementable in other models, these models must contain the same state variables as NEMO. This is obviously not the case for my models. But as noted in section 3.2.2, it is possible to implement the optimal policy through an implicit direct instrument rule that only contains lags and leads of the target variables. When the loss function is given by equation 3.4, the optimal rule can be expressed as

$$i_t = \sum_{j=-l_i}^{h_i} \rho_j E_t i_{t+j} + \sum_{j=-l_\pi}^{h_\pi} \phi_{\pi,j} E_t \bar{\pi}_{t+j} + \sum_{j=-l_y}^{h_y} \phi_{y,j} E_t y_{t+j}, \quad (4.1)$$

where $l_i, h_i, l_\pi, \dots, h_y$ are constants that determine the required number of lags and leads.

A problem with this general rule when we consider several non-nested models is that forecasts of endogenous variables are model-dependent. Levin et al. (2003) propose two ways to deal with this. One is to construct the forecasts of target variables in a model-consistent way, that is, by means of the model that implements the rule. In this case it is not possible to compare the losses generated by a given rule across models; the rule will not be the same when implemented in different models, as the forecasts — and hence the variables the interest rate reacts to — will differ. This makes such an approach infeasible when the purpose is to compare the outcome of the same policy rule in alternative models. The other possibility is to use model-inconsistent forecasts. This means that the model used for calculating the optimal rule is also used to generate forecasts to be used when the rule is implemented in all the other models. This presupposes that the alternative models can be

nested within the rule-generating model, in the sense that all state variables present in the latter are also present in the former. This is not the case for my models, and hence also this approach is infeasible.

I must therefore restrict the allowed information to that which can be observed without the use of a forecasting model. This means that at time t only the variables observed at times $t, t - 1, t - 2, \dots$ can be used when setting the policy rate; that is, $h_i = h_\pi = h_y = 0$ in equation 4.1. This is the approach taken by Orphanides and Williams (2008). It might potentially be quite restrictive if optimal policy in fact depends heavily on forecasts of future states, but as shown below this does not turn out to be too big a problem in NEMO. I will denote this kind of feedback rule that only depends on contemporary or past target variables variables an *implementable* rule¹.

There are two opposing concerns when choosing the number of lags of each variable in the rule, the numbers l_i, l_π and l_y . First, an optimal operational policy rule should not deviate too much from the fully optimal state-contingent policy, both in terms of the welfare loss it generates and when it comes to the dynamic properties of the model economy when the rule is implemented. Second, due to time constraints, the amount of information that is allowed in such a rule should not be too large².

$\% \Delta \mathcal{L}^{opt}$	ρ_1	ρ_2	$\phi_{\pi,0}$	$\phi_{\pi,1}$	$\phi_{\pi,2}$	$\phi_{y,0}$	$\phi_{y,1}$	$\phi_{y,2}$
12.15	-	-	1.88	-	-	0.19	-	-
8.01	0.80	-	0.76	-	-	0.22	-	-
7.72	0.89	-	1.1	-0.49	-	0.37	-0.19	-
6.70	1.8	-0.80	0.83	-0.75	-	0.47	-0.45	-
6.35	1.8	-0.82	1.0	-1.2	0.32	0.27	-0.03	-0.20

Table 4.1: Excess loss in NEMO for optimal policy rules of varying length.

To find the optimal implementable policy rules, I solve the relevant models numerically in Dynare and then solve for the unconditional variances of the endogenous variables. The optimal rule is the one that gives the smallest average of these variances as given by the loss function. Table 4.1 shows the percentage difference between the loss under the optimized implementable rules of varying length (L^{oir}) and the first-best outcome attainable in NEMO (i.e. the outcome under the optimal state-contingent policy, L^{opt}),

¹Since inflation and the output gap are non-predetermined variables in NEMO, Credit NEMO and LGM, they are not actually observable and independent of the model the rule is implemented in. However, it is common to treat them as directly observable (see e.g. Galí 2008).

²To illustrate why the latter can be a problem, consider a crude algorithm that tests 20 values of each parameter included in the rule. If the rule contains three parameters, this means that the loss function is evaluated $20^3 = 8000$ times. If there are six parameters, the number grows to 64 million.

$$\% \Delta \mathcal{L}^{opt} = \frac{L^{oir} - L^{opt}}{L^{opt}}. \quad (4.2)$$

I call this measure the *excess loss*. I find that even a two parameter rule which includes only contemporary inflation and output performs reasonably well, but adding a lagged interest rate term decreases the excess loss by about four percentage points. Adding even more information helps, but there is little to gain from more than eight parameters. I find furthermore that the impulse responses of the target variables to the most important shocks are very similar for optimal state-contingent policy and the optimal eight parameter rule. Thus my choice for the optimal implementable rule is

$$i_t = \rho_1 i_{t-1} + \rho_2 i_{t-2} + \phi_{\pi,0} \bar{\pi}_t + \phi_{\pi,1} \bar{\pi}_{t-1} + \phi_{\pi,2} \bar{\pi}_{t-2} + \phi_{y,0} y_t + \phi_{y,1} y_{t-1} + \phi_{y,2} y_{t-2}. \quad (4.3)$$

In principle, it is possible to improve on this specification by adding other variables that are included in all the models. This is because the expected future target variables in the fully optimal instrument rule can be expressed as functions of in general all the variables at time t . However, adding additional variables to the rule only decreases the loss marginally in NEMO. Including the real exchange rate in the three parameter optimized rule decreases $\% \Delta \mathcal{L}^{opt}$ by less than 0.01 percentage points. Reacting separately to imported and domestic inflation has a similar small effect on the loss. The only endogenous variable that seems to be worth reacting to is wage inflation, but this does not figure in LGM and hence can not be included it in the implementable rule.

It is important to note that the specification given by equation 4.3 is only used when we need to investigate the effects of the optimal NEMO policy in different non-nested models. If we do not require that the performance of the robustified policy can be checked in the alternative models, the optimal state-contingent policy should replace the implementable rule.

4.1.1 The robustness of optimal policy

How well does the optimal policy from one model perform in the other models? That is, how robust are the optimal policies? Table 4.2 shows the absolute and excess losses when using the optimal implementable rule from one model in the other models³. Here, the excess loss

³The absolute loss is multiplied by 10.000 so that standard deviations are expressed in percentage points instead of basis points.

is measured by

$$\% \Delta \mathcal{L}^{oir} = \frac{L^{rule} - L^{oir}}{L^{oir}}, \quad (4.4)$$

where L^{oir} now is the loss under the optimal eight parameter implementable rule for the model in question (the *benchmark* loss for that model). In other words, this is a measure of the per cent increase in loss in model m when switching from a policy that is optimized for m to a policy rule within the same class of rules optimized for an alternative model⁴.

Rule generated in	L^{rule} [% $\Delta \mathcal{L}^{oir}$] evaluated in			
	NEMO	Credit NEMO	LGM	NAM
NEMO	22.1 [0]	5.44 [1.85]	4.84 [41.8]	∞
Credit NEMO	22.5 [1.87]	5.34 [0]	4.95 [45.0]	∞
LGM	27.4 [24.0]	7.81 [46.4]	3.41 [0]	5.04 [142]
NAM	60.9 [176]	246 [4515]	28.5 [735]	2.08 [0]

Table 4.2: Loss and excess loss in one model (the rule implementing model) when using optimal policy from another (the rule generating model).

While some rules optimized for one model can perform reasonably well in alternative models, in other cases the resulting excess losses are huge. Thus my results support the findings of Levin and Williams (2003) for a different set of models. As expected, NEMO and Credit NEMO are relatively tolerant of each other’s optimal policies. These models have the same core structure and main transmission mechanisms of monetary policy. The losses in LGM and NAM are also very similar for NEMO and Credit NEMO policy.

The most striking result is the difference between the policy that is optimized for NAM and those optimized for the other models. NAM require a more timid response to fluctuations both in inflation and in the output gap, as well as less inertia, than the other models. As a result, the excess losses in NEMO, Credit NEMO and LGM are high when the optimal NAM policy is implemented. Furthermore, NAM is unstable with optimal policy from NEMO (and, for similar reasons, for the optimal Credit NEMO policy). This is because the optimal NEMO rule reacts too strongly to fluctuations in the output gap relative to the reaction to inflation fluctuations. The problem is in the timing of the interest rate responses; the policy rate only affects output with a one period lag, and because output growth is negatively autocorrelated, a policy of reacting strongly to output can be destabilizing instead of stabilizing. For example, if output is high in one period, the interest rate will be increased, but then output next period — when the policy change has an effect — turns out to be low. There are no effects from

⁴The parameters of the implementable rules for each model are given in appendix C.

future expectations that can correct for this, and so a small initial shock can generate very long cycles and even instability.

The rules that do well in LGM have even higher coefficients on the output gap, and the optimal NEMO and Credit NEMO policies are seen to generate excess losses above 40% in this model. This is not catastrophic, however, something that can be attributed to the structural similarities between LGM and the two NEMO versions. The reason why the LGM policy rule does not create instability in NAM even though the reaction of output gap fluctuations is strong, is the stronger reaction to inflation for this policy.

4.2 Method and loss measures

The catastrophic performance of the optimal NEMO policy in NAM means that it is important to find some middle ground between this optimal rule and a rule that works better across the alternative models. For weights θ on the simple rule varying in the range $[0, 1]$, I calculate in NEMO the optimal implementable eight-parameter rule of the form given by equation 4.3, when the objective function is the modified loss function given by

$$L^{\text{mod}} = E_0 \sum_{t=0}^{\infty} \beta^t \left\{ (1 - \theta) [\bar{\pi}_t^2 + \lambda_y y_t^2 + \lambda_{\Delta i} (i_t - i_{t-1})^2] + \theta (i_t - i_t^s)^2 \right\}. \quad (4.5)$$

Here, $\theta = 1$ means that the optimal choice of policy is simply the simple rule given by i_t^s , since following this rule mechanically gives $L^{\text{mod}} = 0$. At the other extreme, $\theta = 0$ means that there is no loss (measured by equation 4.5) associated with straying from the simple rule, and hence the optimal NEMO policy given by the last row of table 4.1 is the best choice. For interior values of θ , the policy chosen to minimize equation 4.5 can be seen as a compromise between the goal of minimizing the loss in NEMO and the goal of staying close to the simple rule.

Dynare uses a numerical search algorithm that for each value of θ calculates that implementable eight parameter rule which generates the smallest loss in NEMO measured by 4.5⁵. When I have found the optimal policy rules for a range of θ -values between 0 and 1, I calculate the resulting losses from committing to this robustified optimal NEMO-policy forever in NEMO, Credit NEMO, NAM and LGM. For each rule, Dynare solves the models and calculates the unconditional variances of $\bar{\pi}_t$, y_t and Δi_t . The true welfare loss is then calculated using the original loss function given by equation 3.5 (which is equivalent to equation 4.5

⁵This algorithm is not part of the standard version of Dynare, but has been written by Junior Mairh for Norges Bank.

with $\theta = 0$).

I use two different parameterizations of the loss function. The benchmark has weights that correspond to those used by Norges Bank for calculation of optimal policy in Monetary Policy Report no. 3, 2011 (Norges Bank 2011), namely $\lambda_y = 0.5$ and $\lambda_{\Delta i} = 0.25$. These values reflect the priority of the three objectives outlined in section 3.1, and the fact that they have been in use by Norges Bank makes the analysis more relevant for practical policy making in Norway. In addition, these values are within the range of values found in the literature (see e.g. Levin and Williams 2003). As a test of the results, I repeat the analysis in section 4.3.4 when the weight on output fluctuations (λ_y) is increased from 0.5 to 1.5.

4.2.1 Comparing losses: excess loss and implied inflation premium

Simulations of the four models using the optimal implementable rule for each of them (see table 4.2) show that the size of the loss varies considerable in magnitude across models. The loss in NEMO is considerably higher than in all the three other models, and for NAM the difference is a whole order of magnitude. There seem to be several reasons for these differences. First, variables with the same name do not have the same definition across models. For example, the output gap in LGM is estimated on the HP-filtered GDP series, in NEMO the trend output is endogenously determined, and in NAM there is a constant trend output. When the output gap used for estimating LGM is based on a linear trend, I find that the simulated loss can match the size of the loss from NEMO. Thus this difference might account for a large fraction of the difference in losses between some of the models⁶.

Second, the models have been estimated on data from different sample periods. NEMO and LGM are estimated on a sample that starts in 1993 and ends in 2011, while Credit NEMO is estimated on a sample that goes from 1989 to 2009. Some of the equations in NAM are estimated on samples starting in the 1980s, others on data starting in the late 1990s. If there have been structural breaks during these periods, this might influence the size of losses generated by the respective models.

Third, some of the variables that are exogenous in the original version of NAM have been kept constant at their steady-state values in my simulations. Thus the variation generated by my version of the model will underestimate the actual variation in the target variables predicted by the original version.

Fourth, monetary policy has not been specified in the same way when the models have been estimated. NEMO is estimated assuming that Norges Bank follows the optimal state-contingent policy, while LGM is estimated assuming that a simple rule is being used. As long

⁶Ilbas et al. (2012) avoids this problem by re-estimating their models on the same data set.

as the interest rate is a non-predetermined variable, differences in the policy rules may account for some of the difference in losses. Moreover, when the original policy rule is changed, we also remove some variation in the target variables stemming from the shock in the rule.

Fifth, some of the differences might be attributable to the differences in estimation methodology. NEMO, Credit NEMO and LGM are estimated with Bayesian methods, while the equations constituting NAM are estimated with either OLS or maximum likelihood. However, it is unclear in which way this will influence the variance of the target variables, if at all.

Measuring robustness using the absolute loss values would imply that when NEMO is the reference model, there is little value in robustifying optimal policy, since the losses under almost any policy will be lower than the loss in NEMO. Since it is unreasonable that one of the models should predict much more variation in the target variables than the rest, we should try to correct for the large level differences by measuring the loss generated by any particular policy rule relative to the benchmark loss in the same model. I will consider two measures that achieve this in different ways.

The excess loss $\% \Delta \mathcal{L}^{oir}$ given by 4.4 provides a simple measure. It is reasonable to believe that if the problems mentioned above were corrected for, the benchmark loss would be nearly the same in all the four models. So what is relevant for the policymaker is arguably how well a given rule performs relative to what can be achieved optimally in that model. This way of comparing the performance of policy rules is used by, among others, Levin and Williams (2003) and Levin et al. (2003).

A second measure is the so called "implied inflation premium" (IIP) introduced by Küster and Wieland (2010). IIP measures the increase in the standard deviation of $\bar{\pi}_t$, relative to the outcome under the optimal policy, that is required to increase the loss to the new level while holding the standard deviations of y_t and Δi_t constant. This can be expressed as

$$\text{IIP} = \sqrt{L^{rule} - L^{oir} + (\sigma_{\pi}^{oir})^2} - \sigma_{\pi}^{oir}, \quad (4.6)$$

where σ_{π}^{oir} is the standard deviation of $\bar{\pi}_t$ under the optimal implementable rule⁷. IIP is concave and increasing in the loss L^{rule} , and it is zero when $L^{rule} = L^{oir}$. I will use this measure as an alternative to $\% \Delta \mathcal{L}^{oir}$ due to the fact that the latter may create a wrong impression of the effects of alternative policies (Küster and Wieland 2010). In particular, for models that in general create small losses (such as NAM) the change from optimal policy tend to be overemphasized relative to models with much larger benchmark losses (such as

⁷As before, the standard deviations are expressed in percentage points. The IIP expression is derived in appendix B.

NEMO). The reason is that, say, a one percentage point increase in the standard deviation of inflation will give rise to a much larger change in $\% \Delta \mathcal{L}^{oir}$ when the value of the benchmark loss L^{oir} is small. Such an increase is in absolute terms equal to a change in the loss of 0.2 units in NEMO and 0.03 in LGM.

It is not obvious which of these two measures is the one policymakers should care more about, even though $\% \Delta \mathcal{L}^{oir}$ is the more common in the robustness literature. I will in the following avoid taking a definite stand and instead present both measures in order to get a more complete picture of the differences between policy rules and the possible gains from robustifying optimal policy using such rules.

4.2.2 Simple rules

Due to the abundance of simple monetary policy rules in the literature⁸, there are many possible substitutes for the term i_t^s in equation 4.5. The rules that work well in this respect should preferably generate small losses in all the models, that is, they should be quite robust to model uncertainty in themselves. It is particularly acute that they yield a good performance in models that are not tolerant of the optimal NEMO policy (such as NAM), since we need the simple rule to be an effective insurance against instability and/or high losses caused by the optimal NEMO policy.

In addition, the rules should be quite fault tolerant to the particular choice of weight θ . I denote by *fault tolerance* in this context the degree to which the excess losses are acceptable for θ -values in a neighbourhood of the optimal value⁹. High fault tolerance means that it is less likely that the policymaker will "miss" when choosing the value of θ ; that is, the cost of not setting θ at the optimum is not too high. Furthermore, the weight should not be required to be too high. If that is the case, it is probably better to use the simple rule itself, without recourse to optimal policy in NEMO.

A selection of simple rules along with the values of $\% \Delta \mathcal{L}^{oir}$ and IIP generated in the four models is given in table 4.3. All these rules can be written on the general form

$$i_t = \rho i_{t-1} + (1 - \rho) [\phi_\pi \bar{\pi}_t + \phi_y y_t]. \quad (4.7)$$

Thus the interest rate is set based on the current year-on-year inflation rate and the output gap, and might to some extent also depend on its own lag. I will refer to rules that include

⁸For a survey, see Taylor (1999) and Taylor and Williams (2010).

⁹Fault tolerance can also be measured with respect to the parameter values in a policy rule (Levin and Williams 2003).

all three terms as "three parameter rules", while rules in which the restriction that $\rho = 0$ is imposed are called "two parameter rules". The latter class includes the Taylor rule discussed in section 3.3. When the simple rules are written on the form of equation 4.7, the terms inside the bracket parenthesis correspond to the long run reactions to inflation and the output gap. This makes it easy to compare the reaction coefficients in the two and three parameter rules.

The simple rules I use as cross-checks on optimal policy can be divided roughly into two categories. First, the Taylor rule is a prominent example of a simple *ad hoc* rule that is not optimized in any way, but is thought to function well in a variety of contexts or for some specific purpose. Second, I consider rules that are optimized for the models at hand, namely the Bayesian rules with two (Bayes2) and three (Bayes3) parameters, and the minmax rule. An explanation of these rules and how they are constructed is given below. I also look briefly at some alternative optimized rules that will test the robustness of the results to the measure used for comparison of losses across models, namely Bayesian rules that are optimized for absolute losses instead of excess losses (Bayes2abs and Bayes3abs)¹⁰.

Rule				% $\Delta\mathcal{L}^{oir}$ [IIP]			
	ρ	ϕ_π	ϕ_y	NEMO	Credit NEMO	LGM	NAM
Taylor	–	1.5	0.5	25.4 [0.806]	57.4 [0.875]	136 [1.19]	34.8 [0.365]
Bayes2	–	1.96	0.59	11.5 [0.387]	28.5 [0.488]	95.8 [0.900]	59.4 [0.565]
Bayes3	0.63	2.87	1.68	13.7 [0.458]	28.2 [0.484]	25.7 [0.291]	48.4 [0.479]
Bayes2abs	–	2.16	0.65	10.0 [0.340]	24.3 [0.425]	87.7 [0.838]	76.1 [0.686]
Bayes3abs	0.66	3.53	1.98	9.67 [0.329]	20.6 [0.368]	26.1 [0.294]	60.6 [0.574]
minmax	0.61	2.65	1.52	14.8 [0.491]	30.3 [0.515]	28.2 [0.322]	43.4 [0.438]

Table 4.3: List of simple rules and their performance (in terms of excess loss and IIP) in the four models. The parameters in the rules, except those in the Taylor rule and the minmax rule, have been shortened in the table.

4.3 Robustifying optimal policy

4.3.1 The Taylor rule

There are at least two reasons why it is better to use simple rules found to be robust in the literature. First, if the rules have been shown to function well in other models than the ones I consider, they will be more robust to the kind of model uncertainty I am interested in. Second, such rules will generally be known and trusted by decision-makers, and this may in

¹⁰ All the Bayesian rules are derived by Hoen (2012).

itself motivate their use for cross-checking and make departures from optimal policy easier to accept. This second point applies especially to the Taylor rule, which is probably known by any student of macroeconomics and anyone familiar with central banking. Indeed, there is evidence that policymakers use this rule as a guideline by which to measure their interest rate setting. As Asso et al. (2010) put it,

Taylor-type rules have become the standard by which monetary policy is introduced in macroeconomic models both small and large. They have been used to explain how policy has been set in the past and how policy should be set in the future. Indeed, they serve as benchmarks for policymakers in assessing the current stance of monetary policy and in determining a future policy path.

For these reasons, the Taylor rule is a natural starting point and benchmark for my analysis.

The excess losses (measured by $\% \Delta \mathcal{L}^{oir}$) and the implied inflation premia (IIP) in the four models for values of θ varying between 0 and 1 are plotted in figure 4.1. These are the *loss curves* for the individual models. When $\theta = 0$, the policy is fully optimized for NEMO, and when $\theta = 1$, it is simply the Taylor rule. Since lower values of θ means that the policy rule will be closer to the optimal NEMO policy, the loss curve for NEMO is increasing in θ . Measured by the excess loss, NEMO is the most fault tolerant of the four models, as it generates smaller values of $\% \Delta \mathcal{L}^{oir}$ for all values of θ . This is partly due to the fact that for all but the highest weight on the simple rule, the robustified policy is to some extent optimized for NEMO, but it is also because NEMO seems to be more tolerant than the alternative models of deviations in parameter values from the optimal ones¹¹. In terms of IIP, the loss curve for NEMO is less flat and more similar to the one for Credit NEMO.

For the alternative models, the picture is mixed. While the loss curves for Credit NEMO have similar shapes as those for NEMO, both NAM and LGM display a different pattern. NAM is unstable when the optimal NEMO policy is followed, and the loss generated by this model seems to increase strictly towards ∞ when $\theta \rightarrow 0$. Hence there is a clear advantage in placing some weight on the simple rule when the policymaker has some belief in NAM. As opposed to this, the loss in LGM is much higher for the Taylor rule than for optimal NEMO policy. The reason for this high excess loss is that optimal policy in LGM entails a strong reaction to fluctuations in the output gap, and the model is relatively fault intolerant with respect to deviations from this aspect of the policy rule. In fact, when the response to output is too weak, the Blanchard-Kahn conditions are not satisfied due to instability. This feature is not found in the other models.

¹¹See Hoen (2012) for a discussion of this kind of fault tolerance.

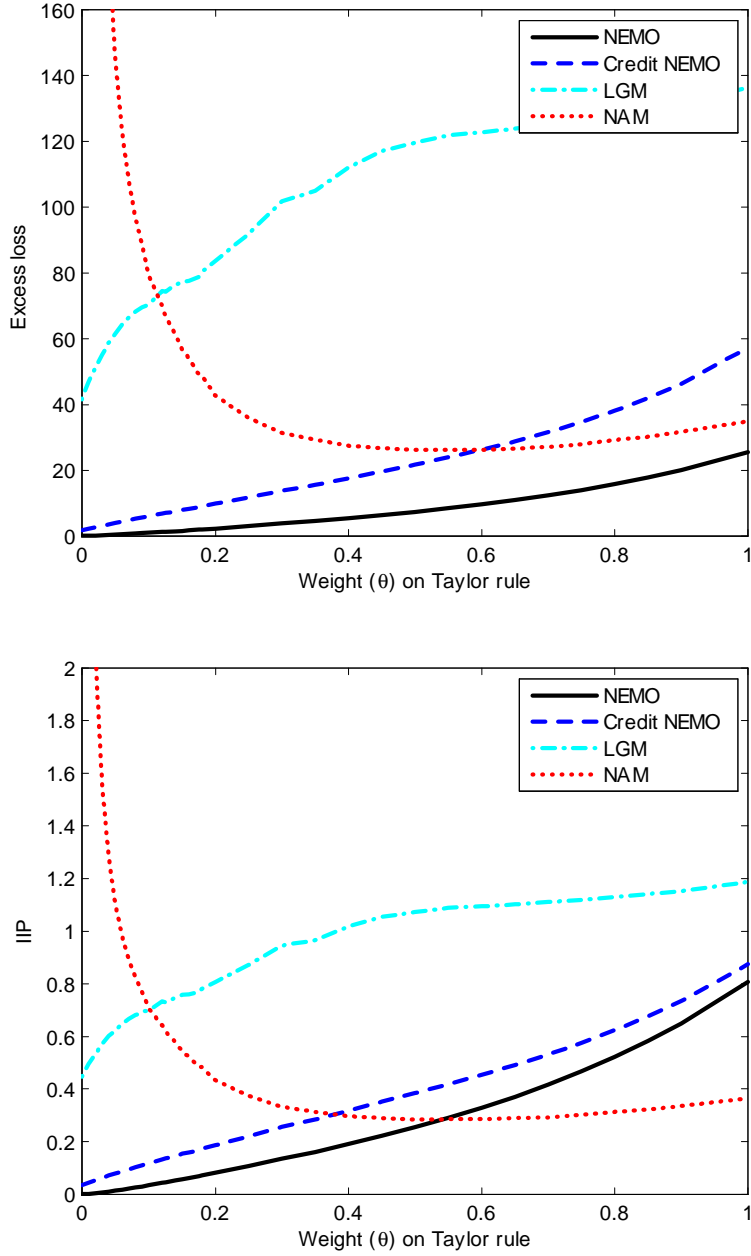

Figure 4.1: Excess loss $\% \Delta \mathcal{L}^{oir}$ and IIP, respectively, as functions of the weight θ on the Taylor rule in the modified loss function.

This method for robustifying optimal NEMO policy works best if the individual losses are close to their minimum values for the same θ -value. That is, the regions of high fault tolerance should be overlapping. When the Taylor rule is the robustifying simple rule, this holds to a certain extent. Increasing the weight on the simple Taylor rule leads to higher excess losses in NEMO, Credit NEMO and LGM, but lower in NAM. However, NAM is relatively fault tolerant for θ -values in the interval between 0.2 and 1, so placing only a small weight on the Taylor rule in the modified loss function is enough to insure policy against catastrophic outcomes should NAM be the correct model.

How much should the policymaker care about deviations from the simple rule? Clearly, which value of θ is optimal depends on how much confidence the policymaker has in the each of the models. Following Cateau (2007), Küster and Wieland (2010) and Brock et al. (2003), I combine the Bayesian approach with the minmax approach in order to calculate what I call the *weighted excess loss*. This can be seen as an operationalization of the policymaker's preferences when there is uncertainty about which model is correct, and it is given by (Küster and Wieland 2010)

$$\mathcal{L}_{ex}^W = (1 - e) \sum_{m \in M} p_m \% \Delta \mathcal{L}_m^{oir} + e \max_{m \in M} \% \Delta \mathcal{L}_m^{oir}, \quad (4.8)$$

where p_m is the probability that model m in the set $M = \{\text{NEMO, Credit NEMO, LGM, NAM}\}$ is the correct one, $\% \Delta \mathcal{L}_m^{oir}$ is the weighted excess loss in model m , and e is the "degree of desired insurance" against the worst case outcome. Thus e can be seen as a measure of the aversion to model uncertainty (as described in section 3.4.1). The function \mathcal{L}_{ex}^W nests the Bayesian and minmax loss functions as special cases: when $e = 0$, I call the preferences "pure Bayesian", while $e = 1$ entails "pure minmax" preferences¹². For all values $e > 0$, a higher weight is implicitly assigned to the model that generates the largest excess loss; for example, when NAM is the worst case model, the total weight given to NAM is $(1 - e)p_{NAM} + e$. p_m and e can either be set on a purely subjective basis or updated using Bayes' theorem after the models have been tested against data. In the following I consider several combinations of these parameters.

The objective is to choose the value of θ that minimizes \mathcal{L}_{ex}^W for given preference parameters. The upper panel of figure 4.2 plots \mathcal{L}_{ex}^W for $\theta \in [0, 1]$ and for different values of e and the probability p_{NEMO} . Since NEMO is the reference model and the one used to calculate optimal policy, it is natural that the probability assigned to it is higher than the probability assigned to any of the other models. For simplicity, an equal probability is given to each of

¹²The robust control framework assumes that preferences are pure minmax.

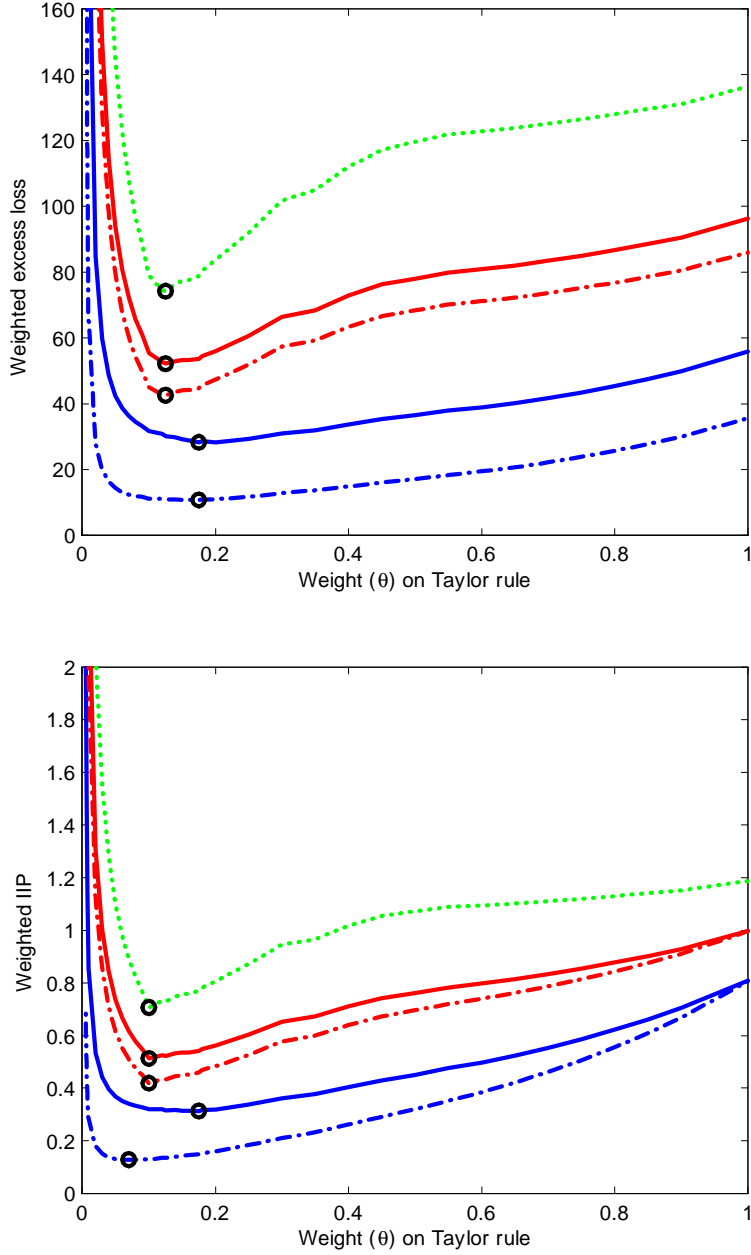

Figure 4.2: Weighted excess loss $\% \Delta \mathcal{L}^{oir}$ (upper panel) and weighted IIP (lower panel) as functions of the weight θ on the Taylor rule in the modified loss function. The blue lines show the value of the excess loss when $e=0$, the red lines when $e=0.5$ and the green line when $e=1$. The solid lines are for $p_{NEMO} = 0.4$, while the dashed lines are for $p_{NEMO} = 0.8$. The black circles mark the minima.

the alternative models. From the figure we can see that the optimal weight is in the range 0.1 – 0.2 regardless of the specific probabilities. In any case, θ should be close to the value at which the loss curves of LGM and NAM cross in figure 4.1.

As an alternative specification of the policymaker’s preferences, let the *weighted IIP* be given by

$$\mathcal{L}_{IIP}^W = (1 - e) \sum_{m \in M} p_m IIP_m + e \max_{m \in M} IIP_m, \quad (4.9)$$

where IIP_m is the IIP in model m . The lower panel of figure 4.2 plots \mathcal{L}_{IIP}^W as a function of θ . When IIP is the relevant measure, the performance of the Taylor rule (i.e. $\theta = 1$) in NEMO relative to its performance in the other models is worse. Still, the optimal weight is almost unchanged at around 0.1, so this result seems to be relatively robust to the choice of loss measure. In both cases, the focus is on avoiding instability in NAM while not creating too much variation in the alternative models.

It is evident from figure 4.1 that these conclusions depend heavily on the weight placed on NAM. Since the loss curves for all the other models have their minima at $\theta = 0$, the optimal value of θ is zero if the policymaker cares neither about the worst case nor about NAM at all. However, raising either p_{NAM} or e to 0.08 implies that the optimal weight rises to 0.1. Thus the policymaker can optimally place some weight on the simple rule even if he does not have a lot of confidence in NAM. At the same time, the optimal weight rises if either LGM or Credit NEMO is given no consideration.

4.3.2 Bayesian rules

The Bayesian rules minimize the average of the excess model losses in NAM, Credit NEMO and LGM. An equal probability is assigned to each of the three models, and the loss generated in each model is weighted by the inverse of the loss in that model under the optimal simple rule of the same class for the same model. The Bayesian, or averaged, loss function in this case is

$$L^B = \frac{1}{3} \frac{L_{NAM}}{L_{NAM,osr}} + \frac{1}{3} \frac{L_{CNEMO}}{L_{CNEMO,osr}} + \frac{1}{3} \frac{L_{LGM}}{L_{LGM,osr}} \quad (4.10)$$

L^m is the loss generated by the Bayesian rule in model m , while $L_{m,osr}$ is the optimal simple rule loss in the same model¹³. For example, for the three parameter Bayesian rule, the

¹³The results do not depend noticeably on whether each model loss is weighted by the optimal simple rule

effective weight given to NAM in 4.10 is one third times the inverse of the loss generated by NAM when the optimal simple three parameter rule for NAM is implemented, $L_{NAM,osr}$. Below I cross-check the results with rules that minimize an average of the *unweighted* losses.

The reference version of NEMO is left out of this optimization. It would be possible also to include NEMO in the minimization of L^B , but I leave it out because NEMO is the reference model under which optimal policy is calculated. This way I avoid giving NEMO weight both in the derivation of the simple robust rule and in the calculation of the optimal implementable policy, and the results will be more clear-cut (Ilbas et al. 2012).

The Bayesian rules can potentially generate smaller losses than the Taylor rule in both Credit NEMO, NAM and LGM, since these rules are optimized to function well in just these models. I use two types of simple Bayesian rules, one that only includes current inflation and output, and one that also includes the lagged interest rate. The two parameter rule facilitates comparisons with the results using the standard Taylor rule, since it includes the same type of information. The three parameter rule provides more flexibility and allows for some degree of inertia. For this reason, it will generate a smaller loss in at least one of the three models. The gain from adding more than three parameters turns out to be small compared to the gain of going from two to three, and for this reason I only consider these two specifications.

Another restriction is that I only analyze rules that are optimal for a loss function that gives equal weight to the losses in each of the models. This simplification is done for two reasons. First, it would be too far-reaching to do the analysis in this section for several rules derived from Bayesian loss functions with different weights. Second, constructing Bayesian rules using other weights on the models is easy when the basic framework is given, and it can be done by the policymaker if needed (see Hoen 2012 for a discussion of such rules). In any case, the rules I do consider have the potential to function well for cross-checking purposes even when we do not weight the models equally.

Comparing the Bayesian rules to the optimal two and three parameter rules for each model separately (see table 4.4 and table 4.3), we see that the parameters in the Bayesian rules can be viewed as averages of the corresponding parameters that are optimal in each individual model. For example, the coefficient on the lagged interest rate, ρ , in the Bayesian three parameter rule is lower than the corresponding ones in the optimal three parameter rules for NEMO, Credit NEMO and LGM, but higher than the one in the optimal NAM rule. Thus the presence of NAM makes the Bayesian policy less history dependent than what would be the case if only Credit NEMO and LGM were given weight in the Bayesian loss function. In general, the coefficients in the Bayesian rules have values in between the

(two or three parameters) loss or the optimal eight parameter rule loss, as this is mostly a matter of scaling. Hoen (2012) uses the former.

Model	ρ	ϕ_π	ϕ_y
NEMO	–	1.88	0.19
NEMO	0.80	3.87	1.14
Credit NEMO	–	3.08	0.57
Credit NEMO	0.96	22.2	8.36
LGM	–	2.19	1.76
LGM	0.80	4.46	5.08
NAM	–	1.12	0.35
NAM	0.34	1.16	0.55

Table 4.4: Optimal three parameter rules in each of the individual models. Taken from Hoen (2012).

most extreme ones found in the rules that are optimal for the models individually.

The two parameter rule

As can be seen in table 4.3, the two parameter rule has coefficients that are not very different from those in the Taylor rule, although it is a bit more aggressive on both inflation and output. For each of the models except NAM, the excess loss is smaller when we allow the parameter values to be optimized. As in the case of the Taylor rule, and for similar reasons, LGM has the worst performance of all the models when the Bayesian rule is implemented. Increasing the coefficient on the output gap in order to create a smaller loss in LGM will involve too large an increase in the losses arising in NAM and Credit NEMO.

Figure 4.3 plots $\%_0\Delta\mathcal{L}^{oir}$ as a function of the weight θ on the two parameter Bayesian rule in the modified loss function. The loss curves have similar shapes to the corresponding ones when the Taylor rule is used as a cross-check on optimal NEMO policy (this is also the case for the IIP loss curves, which are not shown). The losses in NEMO, Credit NEMO and LGM increase strictly with θ , while the loss curve for NAM has a u-shape with a minimum at around $\theta = 0.3$. Again, the only reason for placing a weight on the simple rule is the need to insure against a high loss should NAM be the correct model.

The optimal weight on the two parameter Bayesian rule is in the same region as for the Taylor rule when the probabilities assigned to the various models in equation 4.8 are the same. Furthermore, the weighted excess loss is also on the same level. For example, the minimum value of \mathcal{L}_{ex}^W when $e = 0$ and $p_{NEMO} = 0.4$ is 28.2 when the Taylor rule is used, and 27.5 when the two parameter Bayesian rule is used. This suggests that the Taylor rule can provide almost as good insurance as a rule within the same class that is optimized for these models.

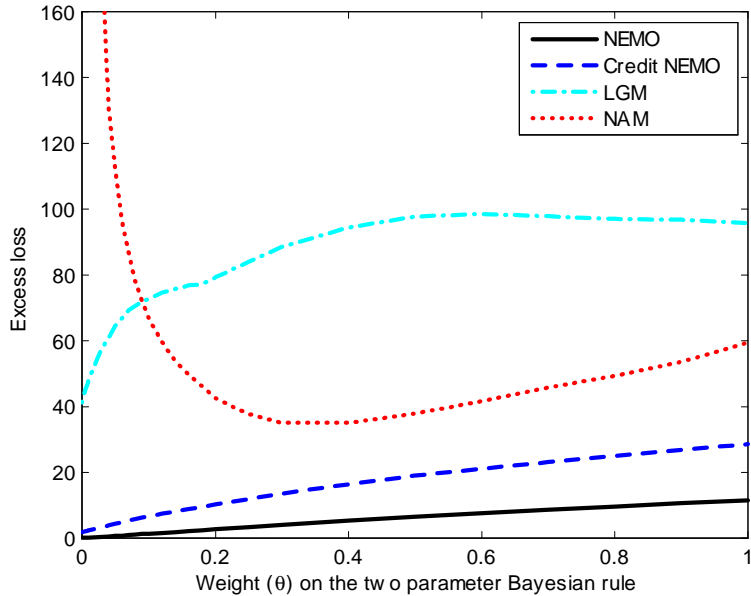

Figure 4.3: Excess loss $\% \Delta \mathcal{L}^{oir}$ as a function of the weight θ on the two parameter Bayesian rule in the modified loss function.

The three parameter rule

In the three parameter Bayesian rule, the long run reaction coefficients are higher than for both the Taylor rule and the two parameter Bayesian rule. This can mainly be attributed to Credit NEMO, in which the optimal three parameter rule is very aggressive on fluctuations in both inflation and the output gap. Coincidentally, the three parameter Bayesian rule is fairly similar to the optimal NEMO rule, even though NEMO is not part of the calculation of this policy. Hence the Bayesian rule performs well in NEMO, evaluated either with $\% \Delta \mathcal{L}^{oir}$ or IIP.

As can be seen in figure 4.4, for every alternative model except NAM and for all θ -values strictly greater than 0, the excess losses are strictly lower for the three parameter rule than for the two parameter rule. The same is the case for the IIP. The gain is particularly large in LGM: allowing for interest rate smoothing in the Bayesian rule decreases $\% \Delta \mathcal{L}^{oir}$ in this model by 70 percentage points. The reason is that there is less of a trade-off between stabilization in NAM and in LGM when we allow the interest rate to depend on its own history. Put differently, it is less costly in terms of the loss in NAM to reduce the loss in LGM. NAM is now the worst case model for all values of θ . Nevertheless, the three parameter Bayesian rule still performs better than the two parameter rule in this model.

This has several implications for how well the three parameter Bayesian rule functions

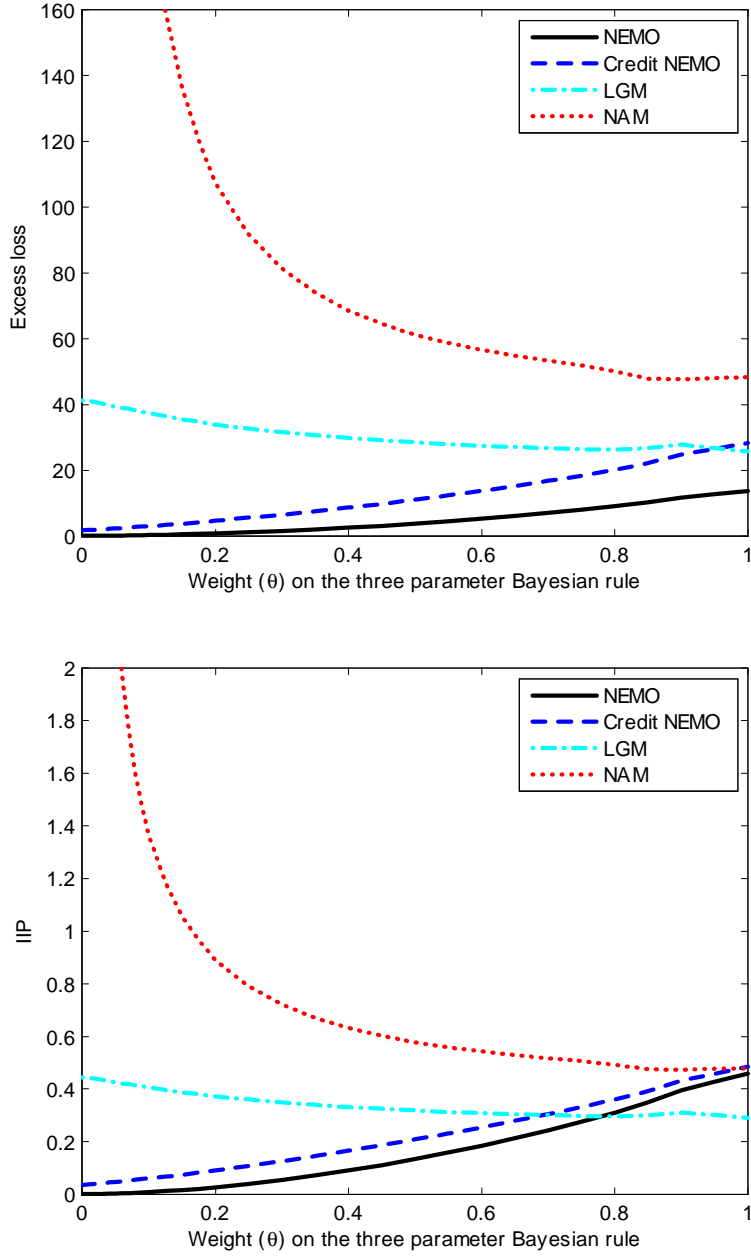

Figure 4.4: Excess loss $\% \Delta \mathcal{L}^{oir}$ and IIP, respectively, as functions of the weight θ on the three parameter Bayesian rule in the modified loss function.

compared to the two parameter rules. There are three main differences. First, with the expectation of NAM, all the models are more fault tolerant with respect to changes in the value of θ from its optimal value. In stark contrast to figure 4.1, figure 4.4 shows that the loss in LGM is now nearly the same for every value of θ . Therefore also the weighted excess loss and IIP are less sensitive to deviations of θ from its optimal value, as can be seen in figure 4.5.

Second, a higher weight on the simple rule is optimal, and this optimal θ -value is more sensitive to the policymaker's preferences over the various models. More specifically, θ should now be in the region 0.2–0.6 if no extra insurance against the worst case outcome is required. This is because the regions of high fault tolerance for the individual models overlap at higher values of θ . The optimal weight on the simple rule increases sharply with the value of e in equation 4.8, and for a moderate degree of insurance against the worst case ($e = 0.5$), $\theta \approx 0.9$ is appropriate. This result can be attributed to the fact that NAM is the worst case model for all θ -values, since the loss in NAM decreases monotonically up to $\theta \approx 0.9$. However, due to the high fault tolerance of all the models, a weight on the simple rule closer to the values that are optimal for the Taylor rule is not catastrophic, at least when the preferences are not pure minmax ($e = 1$). Furthermore, which θ -value is optimal not only depends on the probabilities assigned to the models, but also on whether $\% \Delta \mathcal{L}^{oir}$ or IIP is considered to be the most important measure of performance. Generally, IIP implies a lower optimal weight than does $\% \Delta \mathcal{L}^{oir}$.

Third, the minimum weighted loss is lower, but the difference is not huge. As an example, consider the preferences given by $e = 0$, $p_{NEMO} = 0.4$ and an equal weight on the three other models. The minimum weighted loss is 23% lower in terms of $\% \Delta \mathcal{L}^{oir}$ and 17% lower in terms of IIP when the three parameter Bayesian rule is used than when the Taylor rule is used. The difference is comparable for other values of p_{NEMO} , but it increases with e .

Overall, I find that the most important gain in using a three parameter Bayesian rule rather than the Taylor rule in the modified loss function is that the fault tolerance of the aggregate loss with respect to θ is higher. In other words, there is less of a danger that the policymaker will put too low or too high a weight on the simple rule when this rule is the three parameter Bayesian rule. Again, these results depend heavily on the amount of confidence the policymaker has in NAM. However, the Bayesian rules are constructed by placing an equal weight on the excess loss in each of the alternative models. If the confidence the policymaker has in each model is revised, the Bayesian rules should also be changed.

The choice of weight on the simple rule can be seen as a choice between different combinations of loss in the reference model and losses in the alternative models. Figure 4.6 plots the weighted excess loss for the three alternative models, with an equal weight on each

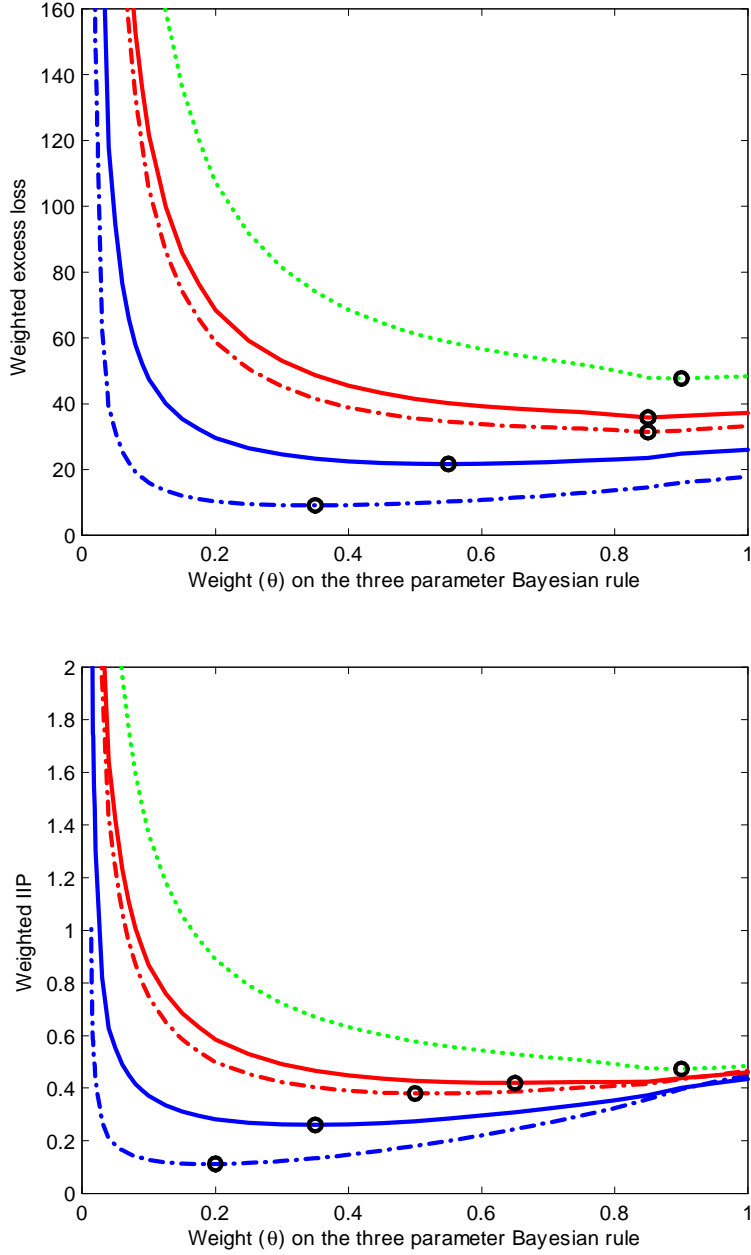

Figure 4.5: Weighted excess loss $\% \Delta \mathcal{L}^{oir}$ (upper panel) and weighted IIP (lower panel) as functions of the weight θ on the three parameter Bayesian rule in the modified loss function. The blue lines show the value of the excess loss when $e=0$, the red lines when $e=0.5$ and the green line when $e=1$. The solid lines are for $p_{NEMO} = 0.4$, while the dashed lines are for $p_{NEMO} = 0.8$. The black circles mark the minima.

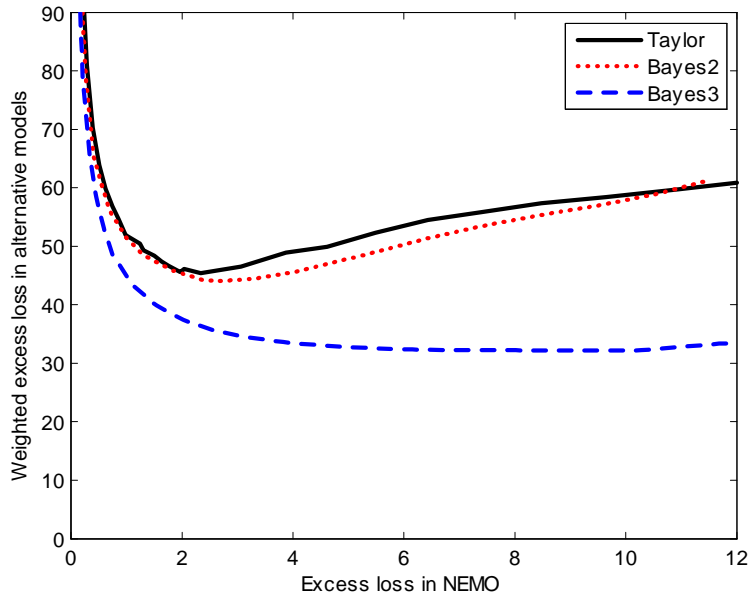

Figure 4.6: Weighted excess loss in the alternative models versus excess loss in NEMO for the Taylor rule and the two and three parameter Bayesian rules. The excess loss in each alternative model is given equal weight.

model loss, against the excess loss in NEMO. Separate lines show the results for the Taylor rule and the two Bayesian rules. Points on each of the lines represent different trade-offs between the excess loss in NEMO and that in the alternative models. For example, should the policymaker be willing to accept a 2% premium on the loss in NEMO in order to gain insurance against other possible models, the weighted excess loss from the alternative models will be close to 38% if the Bayesian three parameter rule is used, and 47% if the Taylor rule is used. Evidently, lower values on both axes are preferred, and hence moving along the graph in the north-east direction can never be optimal. If the policymaker is willing to accept the possibility of large losses in the alternative models in order to get a lower loss in NEMO (i.e. for low values on the horizontal axis), there is not much of a difference between the rules. On the other hand, if a somewhat higher loss in NEMO can be acceptable to the extent that it will yield lower losses in the other models, the Bayesian three parameter rule clearly outperform both of the two parameter rules. Furthermore, if any of the latter are used, we risk choosing too high a weight θ and end up with a higher loss both in NEMO and in the other models. This is just another manifestation of the higher fault tolerance under the three parameter optimized rules.

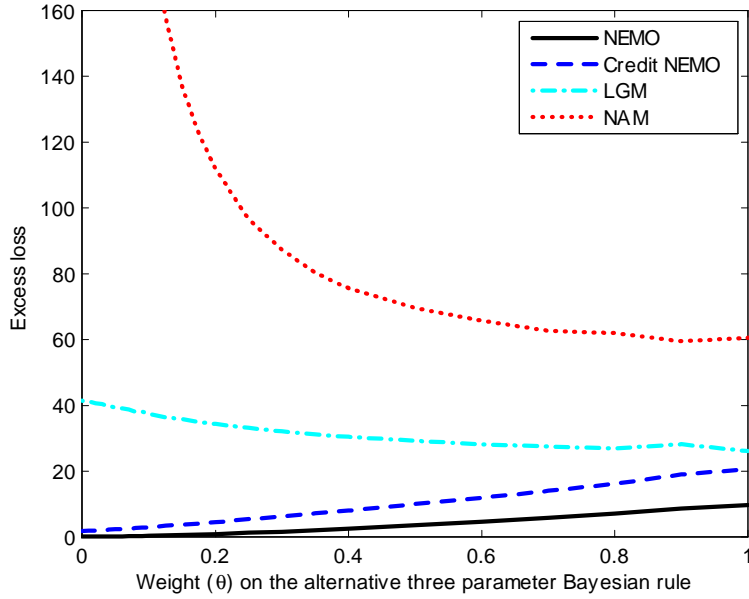

Figure 4.7: Excess loss $\% \Delta \mathcal{L}^{oir}$ as a function of the weight θ on the alternative three parameter Bayesian rule in the modified loss function.

Alternative Bayesian rules

As a cross-check on the results presented above, I consider also Bayesian rules that are optimized for the Bayesian loss function given by

$$L^{B^2} = \frac{1}{3}L_{NAM} + \frac{1}{3}L_{CNEMO} + \frac{1}{3}L_{LGM}. \quad (4.11)$$

Here, the losses in the individual models are not weighted by the inverse of the respective losses under the optimal simple policy rules. Compared to the loss function 4.10, this alternative Bayesian loss gives more weight to Credit NEMO than to LGM and NAM, and more weight to LGM than to NAM. This is because $L_{CNEMO,osr} > L_{LGM,osr} > L_{NAM,osr}$.

The resulting two and three parameter rules are given in table 4.3 (Bayes2abs and Bayes3abs, respectively). The coefficients turn out to be similar to the corresponding ones in the original Bayesian rules, and the two sets of rules also have similar properties when it comes to robustification of optimal policy. The similarities can be seen in figure 4.7, which plots $\% \Delta \mathcal{L}^{oir}$ as a function of θ when the alternative three parameter rule is used for cross-checking. As expected, the rule that minimizes L^{B^2} generate a smaller loss in Credit NEMO and higher losses in LGM and NAM than does the rule that minimizes L^B . The reason is that the loss generated in Credit NEMO carries a higher weight in the former loss function.

However, which of the Bayesian three parameter rules is used does not matter a lot. The loss curves have the same form, and NAM is still the worst case model for all weights θ . Furthermore, both the optimal value of θ and the minimum weighted loss are very similar for the two rules, at least when the preferences are not pure minmax. This indicates that the general conclusions for the Bayesian rules are robust to the precise size of the probabilities assigned to each model when we minimize the average loss.

4.3.3 The minmax rule

The minmax rule is a simple instrument rule that minimizes the largest excess loss given by any of the models I consider. Thus the objective function can be written

$$L^{mm} = \max \left\{ \frac{L_{NAM}}{L_{NAM,osr}}, \frac{L_{CNEMO}}{L_{CNEMO,osr}}, \frac{L_{LGM}}{L_{LGM,osr}} \right\}, \quad (4.12)$$

where the maximization is done with respect to the three relative model losses in the parenthesis¹⁴. Since I measure the losses in each model relative to these optimal losses, I avoid the problem of minmax rules being overly sensitive to the benchmark loss in the individual models (Levin and Williams 2003).

As there is no function in Dynare for finding minmax rules, I have used my own algorithm written for Matlab¹⁵. First I check the losses generated in each model for a wide grid of coefficient values. Then I narrow in on the areas which seem to contain the minimum for the objective function L^{mm} (that is, the smallest maximum excess loss across the three models). This method gives convergence on a set of parameter values in the rule.

The resulting three parameter minmax rule is given in table 4.3. The maximum excess loss is 43.4%, which is generated by this rule in NAM. Even though NAM is still the worst case model, the loss is lower for this rule than for any of the other rules. Compared to the three parameter Bayesian rule, the coefficients in the minmax rule are all smaller, making it perform better in NAM. However, this also ensures that it will generate a higher loss in Credit NEMO and LGM.

Despite the very different criteria, given by equations 4.10 and 4.12, the Bayesian rule and the minmax rule have remarkably similar properties when it comes to robustification. This can be seen in figure 4.8. The loss curves for the individual models have the same shape as before: NAM is the worst case model for all values of θ , LGM is very fault tolerant, and

¹⁴Minimization of this objective function is equivalent to minimization of the largest excess loss $\% \Delta \mathcal{L}^{oir}$ across the three models.

¹⁵The code is available on request.

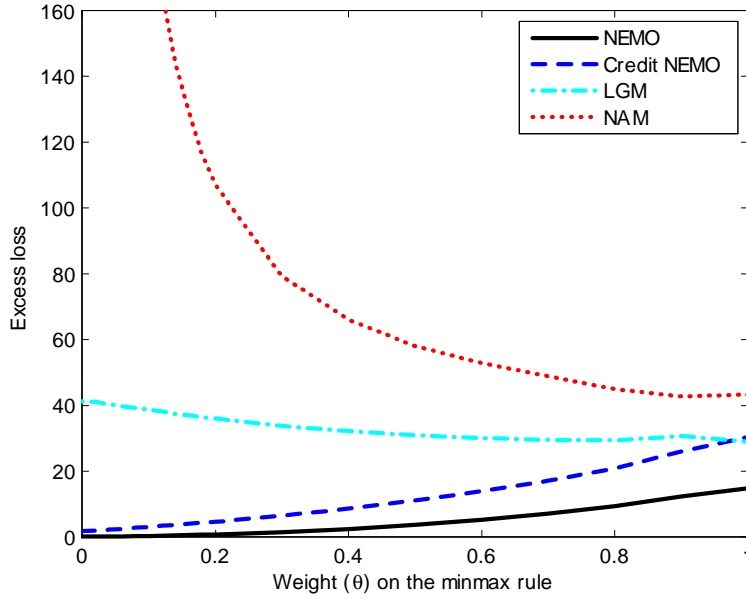

Figure 4.8: Excess loss $\% \Delta \mathcal{L}^{oir}$ as a function of the weight θ on the minmax rule in the modified loss function.

both NEMO and Credit NEMO have loss curves that are increasing in θ . All the models are fault tolerant for values of θ that are not too low. Furthermore, the optimal θ -value is almost identical to that found for the three parameter Bayesian rule when the preferences are pure Bayesian. When some extra consideration is given to the worst case, the minmax rule performs better than the Bayesian rule. This is expected, as by construction the minmax rule dominates all other three parameter rules when the policymaker only cares about the maximum loss. Altogether, I find that the minmax rule does at least as well as the three parameter Bayesian rule for any preferences.

Figure 4.9 plots the maximum excess loss in the alternative models against the excess loss in NEMO for both the Taylor rule and the minmax rule. In this case, we see that it might actually be better to use one of the two parameter rules for robustification if the policymaker will accept an excess loss in NEMO no higher than 2%. However, as shown before, this comes at the expense of lower fault tolerance with respect to the weight θ .

To check the robustness of the results for the minmax rule to the specification of the losses in the minmax loss function 4.12, I have also found a rule that minimizes the largest IIP across the three alternative models. This rule has the form

$$i_t = 0.57i_t + (1 - 0.57) [2.63\pi_t + 1.30y_t]. \quad (4.13)$$

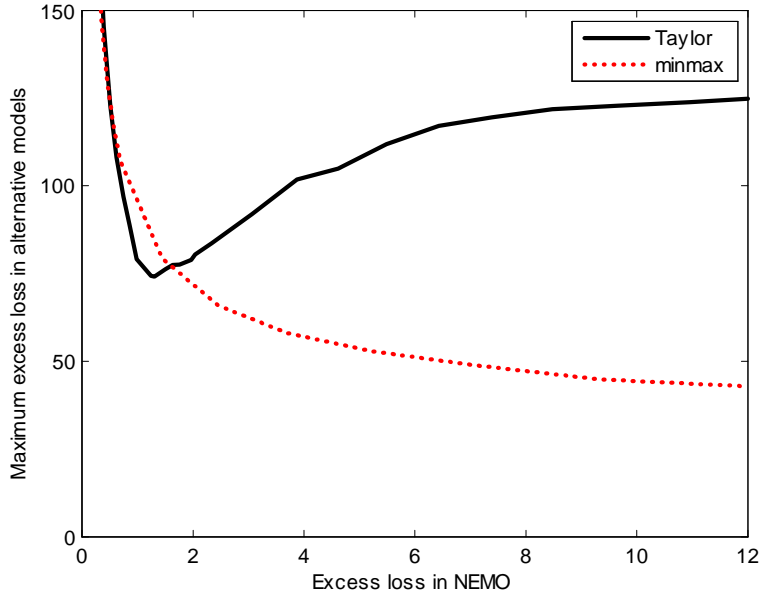

Figure 4.9: Maximum excess loss in the alternative models versus excess loss in NEMO for the Taylor rule and the minmax rule.

Compared to the minmax rule for excess losses, this rule displays less inertia in the interest rate and a smaller reaction to the output gap, and it generates a higher (absolute) loss in LGM and a lower one in Credit NEMO. Still, this rule is similar enough to the original minmax rule that its performance as a cross-check in the modified loss function is also very similar. Thus I find that the results are not heavily dependent on whether the excess loss or the IIP is used in the minmax objective function.

4.3.4 An alternative loss function

The robustness of the results above can be checked by repeating the analysis for a different parameterization of the loss function. I consider only one alternative specification mainly due to time and space constraints, but also because changing the weight $\lambda_{\Delta i}$ on fluctuations in the change in the interest rate seems to give results close to the benchmark case.

In the alternative loss function, the weight on the variance of the output gap is increased from $\lambda_y = 0.5$ to $\lambda_y = 1.5$. Thus this objective gives priority to output stabilization over inflation stabilization. It is not supposed to represent a realistic description of the policymaker's actual preferences, but is rather a means to test whether the method for robustification of optimal policy is viable also if the preferences deviate substantially from the benchmark.

The three parameter Bayesian rule is now given by

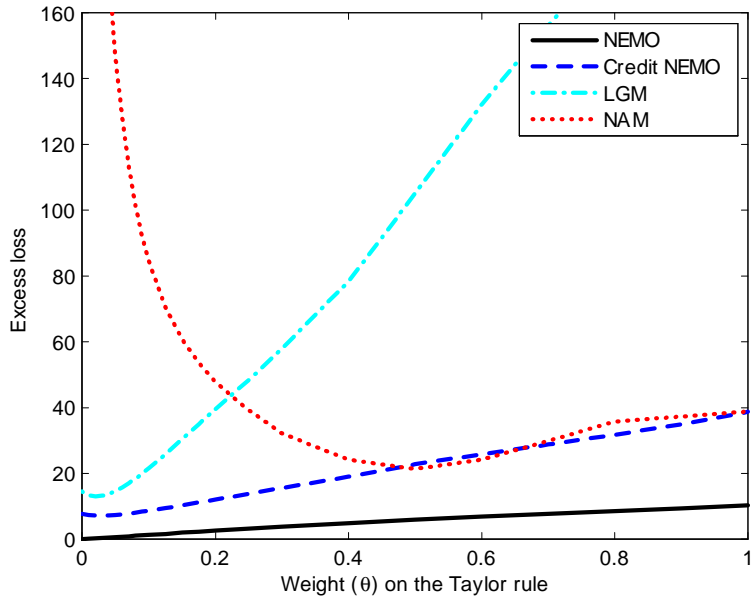

Figure 4.10: Alternative loss function. Excess loss $\% \Delta \mathcal{L}^{oir}$ as a function of the weight θ on the Taylor rule in the modified loss function.

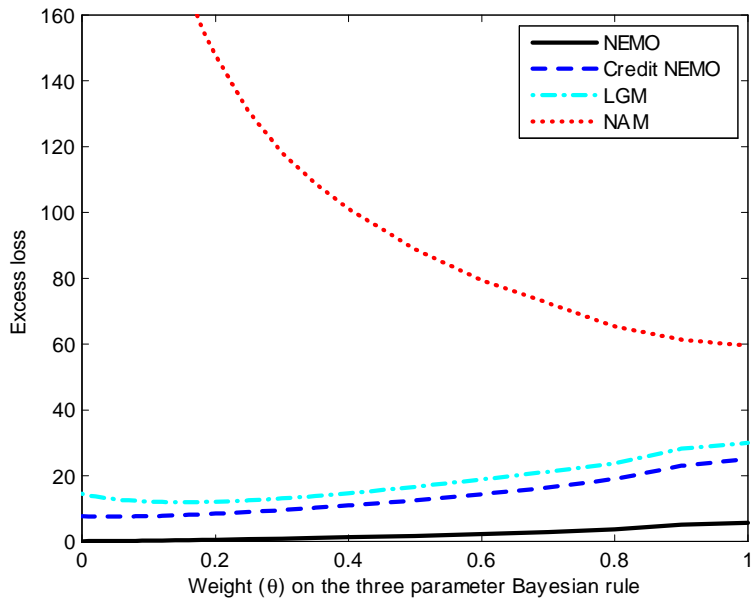

Figure 4.11: Alternative loss function. Excess loss $\% \Delta \mathcal{L}^{oir}$ as a function of the weight θ on the three parameter Bayesian rule in the modified loss function.

$$i_t = 0.68i_{t-1} + (1 - 0.68)[2.69\bar{\pi}_t + 2.38y_t]. \quad (4.14)$$

Comparing this rule to the three parameter Bayesian rule for the benchmark loss function, we see that the major difference is a stronger reaction to the output gap, while the coefficients on interest rate smoothing and inflation are similar.

Figures 4.10 and 4.11 show the results for the Taylor rule and the three parameter Bayesian rule, respectively. One difference from the benchmark loss function is that the optimal implementable NEMO policy calculated with this alternative objective does not create instability in NAM. However, the excess loss $\% \Delta \mathcal{L}^{oir}$ for the pure NEMO policy ($\theta = 0$) is still very high, so there is also here a huge gain from putting some weight on a simple rule in the modified loss function. Furthermore, the general conclusions given for the benchmark loss function still hold for the alternative loss. For both simple rules, the weighted excess loss and the weighted IIP have minima at approximately the same value of θ as before. For the Taylor rule, the optimal value of θ is still between 0.1 and 0.2. For the Bayesian rule, it is between 0.5 and 1. However, the weighted loss is for both simple rules less fault tolerant for this alternative objective, even more so when $e > 0$.

4.3.5 Weighting simple rules and optimal policy

The approach of the previous section can be contrasted with a somewhat simpler method for robustification of optimal policy. Let i_t^s be a simple rule, and let the optimal implementable policy in the reference model be i_t^{NEMO} . Then we can construct a new policy rule given by

$$i_t = (1 - \delta)i_t^{NEMO} + \delta i_t^s, \quad (4.15)$$

where $\delta \in [0, 1]$. This rule specifies an interest rate as a simple average of the rate given by the optimal NEMO policy, i_t^{NEMO} , and the rate given by a simple rule, i_t^s .

Figure 4.12 plots the losses in the four models as functions of the weight δ , evaluated with the benchmark loss function. The endpoints at $\delta = 0$ and $\delta = 1$ correspond exactly to the points at $\theta = 0$ and $\theta = 1$, respectively. By placing a small weight on the Bayesian rule we can achieve the goal of insuring against instability and a very large loss in NAM. Furthermore, the loss curves have the same shapes as those in figure 4.4, and the optimal weight δ lies in the same region as the optimal weight θ .

While this approach is simpler and more straightforward than the method that involves

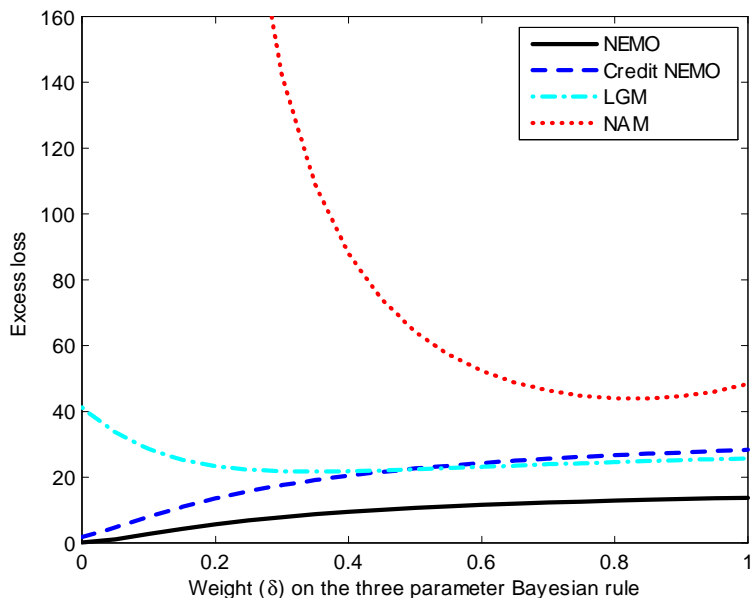

Figure 4.12: Simple weighting of optimal NEMO policy and simple three parameter Bayesian rule. Excess loss as a function of the weight δ on the simple rule.

the modified loss function, a major drawback is that it is not possible to combine it with the optimal state-contingent NEMO policy, since it is practically impossible to express the fully optimal policy as a direct instrument rule for such a large and complicated model. It is unlikely that any central bank will commit itself to following a complicated instrument rule. In practice, monetary policy analysis in Norges Bank combines information from a range of sources outside of NEMO. Forecasts of central variables such as inflation and the policy rate are made conditional on this extra-model information (Alstadheim et al. 2010). The modified loss function fits nicely into this approach, but it is hard to implement extra-model judgement in the same way using simple weighting of rules.

4.4 Discussion of results and conclusion

I have shown that putting some weight on a simple rule in the modified loss function given by equation 4.5 can provide an effective insurance against unwanted outcomes should the reference model NEMO be incorrect. The method is effective even when a very simple and *ad hoc* instrument rule like the Taylor rule is used, but there is nevertheless a gain in terms of fault tolerance if we both allow for interest rate smoothing and optimize the rule for the alternative models. It has little importance whether we use the Bayesian rule — which minimizes an average of the losses in the three alternative models — or the minmax rule —

which minimizes the maximum loss across these three models. Thus the effectiveness of the method is not heavily dependent on the precise coefficients in the simple rule. Furthermore, the results seem to be robust to changes in the relative weights in the welfare loss function.

Which weight on the simple rule that is optimal depends on the type of rule used and the degree of insurance against the worst case that is wanted. Generally, the optimized three parameter rules require a higher weight than the rules without interest rate smoothing, and a higher degree of insurance against the worst case outcome means that the optimal weight rises. For pure Bayesian preferences, a weight between 0.1 and 0.4 is acceptable no matter which simple rule is used. If the desired degree of insurance against the worst case is higher, the optimal weight on the optimized three parameter rules increases while the optimal weight on the Taylor rule is basically unchanged. Thus the recommended weight is more dependent on which simple rule is in use if the policymaker cares about the worst case scenario.

Overall, I find that the proposed method for robustification of optimal policy using the modified loss function is indeed a way to insure against bad outcomes should an alternative model provide a better description of reality than the reference model. This method can be seen as a way of putting the concept of simple rules as "guidelines" into a coherent optimizing framework. Instead of following either a simple rule or a fully optimal policy for a single model mechanically, we ensure that deviations from the optimal policy are in a sense "optimal", since they are intended to avoid bad outcomes should the reference model be wrong. Placing some weight on a simple, robust rule in the modified loss function is a simple way of incorporating extraneous information — information that does not come from the reference model — into the policy making process. Thus the idea of using simple rules as guidelines is not "incomplete and too vague to be operational" (Svensson 2003). Moreover, while it is true that "commitment to an instrument rule does not leave any room for judgemental adjustments and extra-model information" (Svensson 2003), using such a rule together with the optimal state-contingent policy from the reference model does indeed make it possible to incorporate information about other models.

Furthermore, the method is general enough to allow for changes over time both in which simple rules that should be used and in which weight to put on them. If, for example, the policymaker comes to lose confidence in LGM and gain confidence in another model, he can simply adjust the simple rule accordingly and recalculate the robustified optimal policy. Thus the method is simple to implement in practice, even under changing circumstances. Since central banks around the world, and Norges Bank in particular, already implement optimal policy calculations as part of their decision making process, the method is very much a practical solution to the problem of robustness.

4.4.1 Possible extensions

There are many possible extensions to the approach I have used in this thesis. Here I will mention only three issues. First, I have assumed that the policymaker is able to commit fully to a policy rule in the initial period; that is, this commitment is believed by the private sector and will actually be carried out in all future periods. This is clearly unrealistic. Norges Bank's policy decisions are based to some extent on discretion, and there are from time to time revisions of both models and the loss function. This problem could be partly ameliorated by implementing the incomplete commitment approach of Debortoli et al. (2011).

Second, the approach using non-nested models could be combined with the robust control-approach to consider also specification errors in the reference model, in the manner of Cogley et al. (2011). For example, we could surround NEMO with a set of models that are reasonably close to it — in the sense that the structural properties are the same — but have different parameter values and/or shocks. These alternative versions of NEMO might represent actual uncertainty in the estimates of the parameters and standard deviations of shocks. With both nested and non-nested models at hand, we could for example investigate whether policies that are robust to models close to NEMO are also robust to models that have very different properties.

Third, my approach leaves no room for learning over time on the part of the policymaker. In reality, after observing data we would be better suited to judge the relative merits of the models. This new knowledge could be used to update the probabilities placed on these models in the Bayesian loss function and in the weighted loss function. For example, if NEMO repeatedly turned out to outperform the alternative models in forecasting inflation and the output gap, we could gradually give more weight to this model when deciding on a policy.

Chapter 5

Bibliography

- Akram, F. and R. Nymoen (2009). Model selection for monetary policy analysis: How important is empirical validity? *Oxford Bulletin of Economics and Statistics* 71(1), 35–68.
- Alstadheim, R., I. Bache, and A. Holmsen (2010). Monetary policy analysis in practice – a conditional forecasting approach. *Norges Bank Staff Memo* (8).
- An, S. and F. Schorfheide (2007). Bayesian analysis of DSGE models. *Econometric Reviews* 26(2-4), 113–172.
- Asso, P., G. Kahn, and R. Leeson (2010). The Taylor rule and the practice of central banking. *Research paper, Kansas City Fed*.
- Ball, L. (1999). Policy rules for open economies. In J. Taylor (Ed.), *Monetary Policy Rules*. University of Chicago Press.
- Bårdsen, G. (2005). *The econometrics of macroeconomic modelling*. Oxford University Press.
- Bårdsen, G., E. Jansen, and R. Nymoen (2003). Econometric inflation targeting. *The Econometrics Journal* 6(2), 430–461.
- Bårdsen, G. and R. Nymoen (2001). Rente og inflasjon. *Norsk Økonomisk Tidsskrift* 115(2), 125–146.
- Bårdsen, G. and R. Nymoen (2009). Macroeconometric modelling for policy. In T. C. Mills and K. Patterson (Eds.), *Palgrave Handbook of Econometrics*, Volume 2, pp. 851–916. Palgrave Macmillan.
- Barro, R. and D. Gordon (1983). Rules, discretion and reputation in a model of monetary policy. *Journal of Monetary Economics* 12(1), 101–121.

- Batini, N., R. Harrison, and S. Millard (2003). Monetary policy rules for an open economy. *Journal of Economic Dynamics and Control* 27(11-12), 2059–2094.
- Bernanke, B. and F. Mishkin (1997). Inflation targeting: A new framework for monetary policy? *The Journal of Economic Perspectives* 11(2), 97–116.
- Blanchard, O. and C. Kahn (1980). The solution of linear difference models under rational expectations. *Econometrica: Journal of the Econometric Society* 48(5), 1305–1311.
- Brock, W. and S. Durlauf (2005). Local robustness analysis: Theory and application. *Journal of Economic Dynamics and Control* 29(11), 2067–2092.
- Brock, W., S. Durlauf, J. Nason, and G. Rondina (2007). Simple versus optimal rules as guides to policy. *Journal of Monetary Economics* 54(5), 1372–1396.
- Brock, W., S. Durlauf, and K. West (2003). Policy evaluation in uncertain economic environments. *Brookings Papers on Economic Activity* 2003(1), 235–301.
- Brubakk, L., T. A. Husebø, J. Maih, K. Olsen, and M. Østnor (2006). Finding NEMO: Documentation of the Norwegian economy model. *Norges Bank Staff Memo* (6).
- Brubakk, L. and G. Natvik (2010). Credit, asset prices and monetary policy. *Norges Bank Staff Memo* (13).
- Calvo, G. (1983). Staggered prices in a utility-maximizing framework. *Journal of Monetary Economics* 12(3), 383–398.
- Cateau, G. (2007). Monetary policy under model and data-parameter uncertainty. *Journal of Monetary Economics* 54(7), 2083–2101.
- Clarida, R., J. Gali, and M. Gertler (1999). The science of monetary policy: A new Keynesian perspective. *Journal of Economic Literature* 37(4), 1661–1707.
- Clarida, R., J. Gali, and M. Gertler (2000). Monetary policy rules and macroeconomic stability: Evidence and some theory. *The Quarterly Journal of Economics* 115(1), 147–180.
- Clarida, R., J. Galí, and M. Gertler (2001). Optimal monetary policy in open versus closed economies: An integrated approach. *The American Economic Review* 91(2), 248–252.
- Cogley, T., B. De Paoli, C. Matthes, K. Nikolov, and T. Yates (2011). A Bayesian approach to optimal monetary policy with parameter and model uncertainty. *Journal of Economic Dynamics and Control* 35(12), 2186–2212.

- Corsetti, G., L. Dedola, and S. Leduc (2010). Optimal monetary policy in open economies. In B. M. Friedman and M. Woodford (Eds.), *Handbook of Monetary Economics*, Volume 3, pp. 861–933. Elsevier.
- Debortoli, D., J. Maih, and R. Nunes (2011). Loose commitment in medium-scale macroeconomic models: Theory and an application. *International Finance Discussion Paper*.
- Dennis, R. (2010). When is discretion superior to timeless perspective policymaking? *Journal of Monetary Economics* 57(3), 266–277.
- Dixon, H. D. (2008). New Keynesian macroeconomics. In S. N. Durlauf and L. E. Blume (Eds.), *The New Palgrave Dictionary of Economics*. Palgrave Macmillan.
- Ellsberg, D. (1961). Risk, ambiguity, and the savage axioms. *The Quarterly Journal of Economics* 75(4), 643–669.
- Finansdepartementet (2001). For 2001-03-29 nr 278: Forskrift om pengepolitikken. Forskrift til sentralbankloven.
- Galí, J. (2008). *Monetary Policy, Inflation, and the Business Cycle: An introduction to the new Keynesian Framework*. Princeton University Press.
- Galí, J. and T. Monacelli (2005). Monetary policy and exchange rate volatility in a small open economy. *Review of Economic Studies* 72(3), 707–734.
- Giannoni, M. P. (2002). Does model uncertainty justify caution? Robust optimal monetary policy in a forward-looking model. *Macroeconomic Dynamics* 6(01), 111–144.
- Giannoni, M. P. and M. Woodford (2003). Optimal interest rate rules: I. General theory. *NBER Research Paper*.
- Gilboa, I. and D. Schmeidler (1989). Maxmin expected utility with non-unique prior. *Journal of mathematical economics* 18(2), 141–153.
- Greenspan, A. (2003). Monetary policy under uncertainty. Remarks at the Jackson Hole symposium.
- Hansen, L. and T. Sargent (2003). Robust control of forward-looking models. *Journal of Monetary Economics* 50(3), 581–604.
- Hansen, L. and T. Sargent (2008). *Robustness*. Princeton University Press.

- Hansen, L. and T. Sargent (2010). Wanting robustness in macroeconomics. In B. M. Friedman and M. Woodford (Eds.), *Handbook of Monetary Economics*, Volume 3, pp. 1097–1157. Elsevier.
- Hodrick, R. J. and E. C. Prescott (1997). Postwar U.S. business cycles: An empirical investigation. *Journal of Money, Credit and Banking* 29(1), 1–16.
- Hoen, M. B. (2012). The golden interest rule – Robust simple interest rate rules for the Norwegian economy. Master’s thesis, University of Oslo.
- Holmsen, A., J. Qvigstad, Ø. Røisland, and K. Solberg-Johansen (2008). Communicating monetary policy intentions: The case of Norges Bank. *Norges Bank Working Paper* (20).
- Iacoviello, M. (2005). House prices, borrowing constraints, and monetary policy in the business cycle. *The American Economic Review* 95(3), 739–764.
- Iacoviello, M. and S. Neri (2010). Housing market spillovers: evidence from an estimated DSGE model. *American Economic Journal: Macroeconomics* 2(2), 125–164.
- Ilbas, P., Ø. Røisland, and T. Sveen (2012). Robustifying optimal monetary policy. Mimeo.
- King, R. and M. Watson (1998). The solution of singular linear difference systems under rational expectations. *International Economic Review* 39(4), 1015–1026.
- Kiyotaki, N. and J. Moore (1997). Credit cycles. *Journal of Political Economy* 105(2), 211–248.
- Küster, K. and V. Wieland (2010). Insurance policies for monetary policy in the euro area. *Journal of the European Economic Association* 8(4), 872–912.
- Kydland, F. and E. Prescott (1977). Rules rather than discretion: The inconsistency of optimal plans. *The Journal of Political Economy* 85(3), 473–491.
- Leitemo, K. (2006). Targeting inflation by forecast feedback rules in small open economies. *Journal of Economic Dynamics and Control* 30(3), 393–413.
- Leitemo, K. and U. Söderström (2008). Robust monetary policy in a small open economy. *Journal of Economic Dynamics and Control* 32(10), 3218–3252.
- Levin, A., A. Onatski, J. Williams, and N. Williams (2005). Monetary policy under uncertainty in micro-founded macroeconometric models. *NBER Working Papers*.

- Levin, A., V. Wieland, and J. Williams (1999). Robustness of simple monetary policy rules under model uncertainty. In J. Taylor (Ed.), *Monetary policy rules*. University Of Chicago Press.
- Levin, A., V. Wieland, and J. Williams (2003). The performance of forecast-based monetary policy rules under model uncertainty. *American Economic Review* 93(3), 622–645.
- Levin, A. and J. Williams (2003). Robust monetary policy with competing reference models. *Journal of Monetary Economics* 50(5), 945–975.
- McCallum, B. (1988). Robustness properties of a rule for monetary policy. In *Carnegie-Rochester conference series on public policy*, Volume 29, pp. 173–203. Elsevier.
- McCallum, B. (1999). Issues in the design of monetary policy rules. In J. Taylor and M. Woodford (Eds.), *Handbook of macroeconomics*, Volume 1, pp. 1483–1530. Elsevier.
- McCallum, B. T. and E. Nelson (2005). Targeting versus instrument rules for monetary policy. *Federal Reserve Bank of St. Louis Review* 87(5), 597–611.
- Monacelli, T. (2006). Monetary policy in a low pass-through environment. *Journal of Money, Credit, and Banking* 37(6), 1047–1066.
- Norges Bank (2011, October). Monetary policy report 3/2011. Reports from the Central Bank of Norway.
- Norges Bank (2012, March). Monetary policy report 1/2012. Reports from the Central Bank of Norway.
- Onatski, A. and J. H. Stock (2002). Robust monetary policy under model uncertainty in a small model of the U.S. economy. *Macroeconomic Dynamics* 6(1), 85–110.
- Orphanides, A. and J. C. Williams (2008). Learning, expectations formation, and the pitfalls of optimal control monetary policy. *Journal of Monetary Economics* 55, Supplement(0), 80 – 96.
- Qvigstad, J. F. (2006). When does an interest rate path look good? Criteria for an appropriate future interest rate path. *Norges Bank Working Paper*.
- Rogoff, K. (1985). The optimal degree of commitment to an intermediate monetary target. *The Quarterly Journal of Economics* 100(4), 1169–1189.
- Rotemberg, J. J. (1982). Monopolistic price adjustment and aggregate output. *The Review of Economic Studies* 49(4), 517–531.

- Rudebusch, G. and L. E. Svensson (1999). Policy rules for inflation targeting. In J. Taylor (Ed.), *Monetary Policy Rules*. University of Chicago Press.
- Svensson, L. E. (1999). Inflation targeting as a monetary policy rule. *Journal of Monetary Economics* 43(3), 607–654.
- Svensson, L. E. (2000). Open-economy inflation targeting. *Journal of International Economics* 50(1), 155–183.
- Svensson, L. E. (2003). What is wrong with Taylor rules? Using judgment in monetary policy through targeting rules. *Journal of Economic Literature* 41(2), 426–477.
- Taylor, J. and J. Williams (2010). Simple and robust rules for monetary policy. In *Handbook of Monetary Economics*, Volume 3, pp. 829–859. North-Holland.
- Taylor, J. B. (1993). Discretion versus policy rules in practice. In *Carnegie-Rochester conference series on public policy*, Volume 39, pp. 195–214. Elsevier.
- Taylor, J. B. (Ed.) (1999). *Monetary Policy Rules*. University of Chicago Press.
- Taylor, J. B. (2001). The role of the exchange rate in monetary-policy rules. *The American Economic Review* 91(2), 263–267.
- Williams, J. (2003). Simple rules for monetary policy. *Federal Reserve Bank of San Francisco Economic Review*, 1–12.
- Woodford, M. (2003). *Interest and prices: Foundations of a theory of monetary policy*. Princeton University Press.

Appendix A

Complete models

The complete versions of NEMO, LGM and NAM, along with a description of variable names, is given below. Credit NEMO is not included, as this model is very similar to NEMO. Parameter values are not given except for LGM, which has been re-estimated as part of this thesis. Foreign variables in Credit NEMO, NAM and LGM are modelled as in NEMO to the extent that this is possible (see chapter 2). All variables except growth rates and interest rates are in logs, and in NEMO, Credit NEMO and LGM they are also deviations from the respective (log) steady state values.

A.1 NEMO

A.1.1 List of variables

y_t output gap

y_t^* foreign GDP

c_t total consumption

c_t^{sa} consumption savers

c_t^{sp} consumption spenders

a_t final good

t_t intermediate good production

q_t domestically produced intermediate goods used in production of the final good

m_t imported intermediate goods used in production of the final good

m_t^* exported intermediate goods

l_t labour hours

k_t capital stock

u_t utilization rate of capital

inv_t capital investments

inv_t^{oil} oil investments

g_t government spending

π_t quarterly annualized CPI inflation

π_t^* quarterly annualized foreign inflation

π_t^Q quarterly inflation on domestic intermediate goods

π_t^M quarterly inflation on imported intermediate goods

π_t^{M*} quarterly inflation on exported intermediate goods

π_t^W quarterly nominal wage inflation

p_t^Q real price on domestic intermediate goods

p_t^M real price on imported intermediate goods

p_t^{M*} real price on exported intermediate goods

w_t real wage

mc_t real marginal costs

mc_t^* foreign real marginal costs

mrs_t marginal rate of substitution between consumption and leisure

$i_{q,t}$ quarterly domestic nominal interest rate

$i_{q,t}^*$ quarterly foreign nominal interest rate

r_t^K real return to capital

s_t quarterly real exchange rate

b_t domestic holdings of foreign bonds

ω_t elasticity of substitution between labour inputs

θ_t^H elasticity of substitution between domestically produced intermediates

θ_t^F elasticity of substitution between foreign intermediates used in domestic production

$\theta_t^{F^*}$ elasticity of substitution between domestic intermediates in foreign production

ν_t share of domestic intermediates used in domestic production

ν_t^* share of foreign intermediates used in foreign production

π_t^Z shock to the growth rate of technology

z_t^L temporary labour augmenting productivity shock

z_t^I shock to investments

z_t^B risk premium shock

z_t^U shock to consumption preferences

z_t^M shock to imports

A.1.2 Model

Final goods

$$a_t = \nu q_t + (1 - \nu)m_t \tag{A.1}$$

$$q_t = a_t - p_t^Q \tag{A.2}$$

$$m_t = a_t - p_t^M \tag{A.3}$$

$$m_t^* = y_t^* - \mu^*[p_t^{M^*} + f_{51}(p_t^M - s_t)] - \frac{\nu^*}{1 - \nu^*}\nu_t^* \tag{A.4}$$

Intermediate goods

Production

$$t_t = f_{61}(l_t + z_t^L) + f_{62}[u_t + k_{t-1} - \pi_t^Z] \quad (\text{A.5})$$

$$k_t = \frac{inv}{k} inv_t + f_{81}(k_{t-1} - \pi_t^Z) \quad (\text{A.6})$$

$$r_t^K = mc_t + \frac{1}{\xi}(t_t - (u_t + k_{t-1} - \pi_t^Z)) \quad (\text{A.7})$$

$$mc_t = w_t + \frac{1}{\xi}(l_t - t_t) + \frac{1 - \xi}{\xi} z_t^L \quad (\text{A.8})$$

$$\begin{aligned} inv_t + \pi_t^Z - k_{t-1} &= f_{111}(inv_{t-1} + \pi_{t-1}^Z - k_{t-2}) + f_{112}E_t \{ inv_{t+1} + \pi_{t+1}^Z - k_t \} \\ &\quad - f_{113}E_t \{ (i_{q,t} - \pi_{t+1}) - f_{114}r_{t+1}^K \} - f_{115}E_t \{ \beta z_{t+1}^I - z_t^I \} \end{aligned} \quad (\text{A.9})$$

$$\phi^U u_t = r_t^K \quad (\text{A.10})$$

Domestic prices

$$\pi_t^Q = \frac{\beta}{(1 + \beta)} E_t \pi_{t+1}^Q + \frac{1}{(1 + \beta)} \pi_{t-1}^Q + f_{131}(mc_t - p_t^Q) - f_{132} \theta_t^H \quad (\text{A.11})$$

$$\pi_t^Q = \pi_t + p_t^Q - p_{t-1}^Q \quad (\text{A.12})$$

Export prices

$$\pi_t^{M*} = \frac{\beta}{1 + \beta} E_t \pi_{t+1}^{M*} + \frac{1}{1 + \beta} \pi_{t-1}^{M*} + f_{151}(mc_t - p_t^{M*} - s_t) - f_{152} \theta_t^F \quad (\text{A.13})$$

$$\pi_t^{M*} = \pi_t^* + p_t^{M*} - p_{t-1}^{M*} \quad (\text{A.14})$$

Import prices

$$\pi_t^M = \frac{\beta}{1 + \beta} E_t \pi_{t+1}^M + \frac{1}{1 + \beta} \pi_{t-1}^M + f_{171}(mc_t^* - p_t^M + s_t) - f_{172} \theta_t^F \quad (\text{A.15})$$

$$\pi_t^M = \pi_t + p_t^M - p_{t-1}^M \quad (\text{A.16})$$

Households

$$c_t^{sa} = f_{191} E_t c_{t+1}^{sa} + f_{192} c_{t-1}^{sa} - f_{193} E_t \{i_{q,t} - \pi_{t+1}\} - f_{194} \pi_t^Z + f_{195} z_t^U \quad (\text{A.17})$$

$$s_t = f_{201} E_t s_{t+1} - E_t \{i_{q,t} - \pi_{t+1}\} + E_t \{i_{q,t}^* - \pi_{t+1}^*\} + z_t^B \quad (\text{A.18})$$

$$mrs_t = \zeta l_t + f_{211} (\pi_t^Z c_t^{sa} - b^c c_{t-1}^{sa}) + f_{212} \pi_t^Z \quad (\text{A.19})$$

$$c_t^{sp} = w_t + l_t \quad (\text{A.20})$$

Wage-setting

$$\pi_t^W = \frac{\beta}{1+\beta} E_t \pi_{t+1}^W + \frac{1}{1+\beta} \pi_{t-1}^W - f_{231} (w_t - mrs_t) - f_{232} \omega_t \quad (\text{A.21})$$

$$\pi_t^W = \pi_t + w_t - w_{t-1} + \pi_t^Z \quad (\text{A.22})$$

Market clearing

$$a_t = \frac{c}{a} c_t + \frac{inv}{a} inv_t + \frac{inv^{oil}}{a} inv_t^{oil} + \frac{g}{a} g_t \quad (\text{A.23})$$

$$t_t = \frac{q}{t} q_t + f_{261} \frac{m^*}{t} m_t^* \quad (\text{A.24})$$

$$c_t = slc \frac{c^{sp}}{c} c_t^{sp} + (1 - slc) \frac{c^{sa}}{c} c_t^{sa} \quad (\text{A.25})$$

$$y_t = \frac{a}{y} a_t + \frac{x}{y} m_t^* - \frac{x}{y} [m_t + f_{291} m_t^* + z_t^M] \quad (\text{A.26})$$

Foreign block

$$y_t^* = \lambda^{y^*} y_{t-1}^* + \varepsilon_t^{y^*} \quad (\text{A.27})$$

$$\pi_t^* = \lambda^{\pi^*} \pi_{t-1}^* + \varepsilon_t^{\pi^*} \quad (\text{A.28})$$

$$i_{q,t}^* = \lambda^{i^*} i_{q,t-1}^* + \varepsilon_t^{i^*} \quad (\text{A.29})$$

$$mc_t^* = \lambda^{mc^*} mc_{t-1}^* + \varepsilon_t^{mc^*} \quad (\text{A.30})$$

$$\nu_t^* = \lambda^{\nu^*} \nu_{t-1}^* + \varepsilon_t^{\nu^*} \quad (\text{A.31})$$

Domestic shock processes

$$g_t = \lambda^G g_{t-1} + \varepsilon_t^G \quad (\text{A.32})$$

$$inv_t^{oil} = \lambda^{oil} inv_{t-1}^{oil} + \varepsilon_t^{oil} \quad (\text{A.33})$$

$$\pi_t^Z = \lambda^{\pi^Z} \pi_{t-1}^Z + \varepsilon_t^{\pi^Z} \quad (\text{A.34})$$

$$z_t^U = \lambda^U z_{t-1}^U + \varepsilon_t^U \quad (\text{A.35})$$

$$z_t^{inv} = \lambda^{inv} z_{t-1}^{inv} + \varepsilon_t^{inv} \quad (\text{A.36})$$

$$z_t^M = \lambda^M z_{t-1}^M + \varepsilon_t^M \quad (\text{A.37})$$

$$z_t^L = \lambda^L z_{t-1}^L + \varepsilon_t^L \quad (\text{A.38})$$

$$\omega_t = \lambda^\omega \omega_{t-1} + \varepsilon_t^\omega \quad (\text{A.39})$$

$$z_t^B = \lambda^B z_{t-1}^B + \varepsilon_t^B \quad (\text{A.40})$$

$$\theta_t^H = \lambda^{\theta^H} \theta_{t-1}^H + \varepsilon_t^{\theta^H} \quad (\text{A.41})$$

A.2 NAM

A.2.1 List of variables

All growth rates and interest rates except i_t are expressed in per cent.

y_t output

p_t consumer price index

v_t nominal exchange rate, trade-weighted

z_t productivity (value added per man hour)

$Trend_t$ trend growth in productivity

u_t unemployment rate, registered

w_t nominal hourly wage costs

g_t government sector expenditure
 $T1_t$ payroll tax rate
 po_t oil prices
 pe_t electricity, fuel and lubricants prices in the CPI
 l_t nominal credit volume
 R_t money market interest rate (3 month euro-krone interest rate)
 i_t quarterly annualized domestic nominal interest rate (in basis points)
 R_t^* foreign interest rate (ECU weighted effective interest rate on foreign bonds)
 $R_{L,t}$ average interest rate on bank loans
 $R_{B,t}$ yield on six year government bonds, quarterly average
 $R_{B,t}^*$ yield on long-term foreign bonds, NOK basket weighted
 p_t^* consumer prices abroad, in foreign currency
 pi_t price deflator of total imports
 pi_t^* producer price index, trading partners
 $\bar{\pi}_t$ year-on-year CPI inflation rate
 $\bar{\pi}_t^*$ year-on-year foreign CPI inflation rate

A.2.2 Model

The following variables are held constant during simulations, but are included in the equations below: p_t^* , π_t^* , po_t , pi_t^* , pe_t , $T1_t$, $Trend_t$, g_t . In addition, all constants from the original model specification are set equal to zero.

$$\begin{aligned}\Delta v_t &= -f_{11}\{(v_{t-1} + p_{t-1}^* - p_{t-1}) + f_{12}[(R_{t-1} - \bar{\pi}_{t-1}) - (R_{t-1}^* - \bar{\pi}_{t-1}^*)]\} \\ &\quad - f_{13}\Delta(R_t - R_t^*) - f_{14}\Delta^2 p_{t-1} + \epsilon_t^v\end{aligned}\quad (\text{A.42})$$

$$\begin{aligned}\Delta p i_t &= -f_{21}[(p i_{t-1} - v_{t-1} - p i_{t-1}^*) - f_{22}(p_{t-1} - v_{t-1} - p_{t-1}^*)] \\ &\quad + f_{23}\Delta v_t + f_{25}\Delta p i_t^* + \epsilon_t^{p i}\end{aligned}\quad (\text{A.43})$$

$$\begin{aligned}\Delta p_t &= -f_{31}[p_{t-3} - f_{32}(w_{t-1} - z_{t-1}) - f_{33}p i_{t-1}] - f_{34}\Delta z_t + f_{35}\Delta p_{t-2} \\ &\quad + f_{36}\Delta p i_t + f_{37}\Delta p e_t + f_{38}\Delta y_{t-1} + \epsilon_t^p\end{aligned}\quad (\text{A.44})$$

$$\begin{aligned}\Delta w_t &= -f_{41}[(w_{t-1} - p_{t-2} - z_{t-1}) + f_{42}u_{t-4}] + f_{43}\Delta p_t + f_{44}\Delta p_{t-1} \\ &\quad - f_{45}(\Delta^2 u_{t-1} + \Delta u_{t-3}) + f_{46}\Delta T1_t + \epsilon_t^w\end{aligned}\quad (\text{A.45})$$

$$\begin{aligned}\Delta z_t &= -f_{51}[z_{t-3} - f_{52}(w_{t-1} - p_{t-1}) - f_{53}Trend_t - f_{54}u_{t-2}] \\ &\quad + f_{55}\Delta(w_t - p_t) - f_{56}\Delta_2 z_{t-1} + \epsilon_t^z\end{aligned}\quad (\text{A.46})$$

$$\begin{aligned}\Delta u_t &= -f_{61}\{u_{t-1} - f_{62}\Delta(w_{t-2} - p_{t-2}) - f_{63}[(R_{L,t-2} - \bar{\pi}_{t-2}) \\ &\quad - 100\Delta_4 y_{t-2}]\} + f_{64}\Delta u_{t-1} - f_{65}\Delta u_{t-4} - f_{66}\Delta u_{t-5} + \epsilon_t^u\end{aligned}\quad (\text{A.47})$$

$$\begin{aligned}\Delta y_t &= -f_{71}[y_{t-2} - f_{72}\Delta g_{t-1} - f_{73}(v_{t-1} + p_{t-1}^* - p_{t-1}) \\ &\quad + f_{74}(R_{L,t-1} - \bar{\pi}_{t-1})] - f_{75}\Delta y_{t-1} + f_{76}\Delta g_t + f_{77}\Delta(l_{t-1} - p_{t-1}) \\ &\quad + \epsilon_t^y\end{aligned}\quad (\text{A.48})$$

$$\begin{aligned}\Delta(l_t - p_t) &= -f_{81}[(l_{t-3} - p_{t-3}) - f_{82}y_{t-4} + f_{83}(R_{L,t-4} - R_{B,t-4})] \\ &\quad + f_{84}\Delta_2 y_{t-2} + f_{85}\Delta^2(w_t - p_t) + \epsilon_t^{(l-p)}\end{aligned}\quad (\text{A.49})$$

$$\Delta R_{L,t} = -f_{91}(R_{L,t-1} - f_{92}R_{B,t-1} - f_{93}R_{t-1}) + f_{94}\Delta R_t + \epsilon_t^{R,L}\quad (\text{A.50})$$

$$\begin{aligned}\Delta R_{B,t} &= -f_{101}(R_{B,t-1} - f_{102}R_{t-1} - f_{103}R_{B,t-1}^*) + f_{104}\Delta R_t \\ &\quad + f_{105}\Delta R_t^* + \epsilon_t^{R,B}\end{aligned}\quad (\text{A.51})$$

$$i_t = \frac{R_t}{100}\quad (\text{A.52})$$

$$\bar{\pi}_t = \frac{p_t - p_{t-4}}{p_{t-4}}\quad (\text{A.53})$$

A.3 LGM

A.3.1 List of variables

π_t^H quarterly annualized domestic goods inflation (GDP deflator)

π_t^F quarterly annualized imported goods inflation

π_t quarterly annualized CPI inflation

$\pi_{q,t}$ quarterly CPI inflation

y_t output gap

ψ_t^F law-of-one-price gap

s_t terms of trade

i_t quarterly annualized domestic nominal interest rate

$i_{q,t}$ quarterly domestic nominal interest rate

q_t quarterly real exchange rate

$i_{q,t}^*$ quarterly foreign nominal interest rate

$\pi_{q,t}^*$ quarterly foreign inflation rate

y_t^* foreign output gap

A.3.2 Model

$$\begin{aligned}\pi_t^H &= \mu_H E_{t-1} \pi_{t+1}^H + (1 - \mu_H) \sum_{j=1}^4 \alpha_j \pi_{t-j}^H + \kappa_y E_{t-1} y_t \\ &\quad + \kappa_\psi E_{t-1} \psi_t^F + \epsilon_t\end{aligned}\tag{A.54}$$

$$\pi_t^F = \mu_F E_{t-1} \pi_{t+1}^F + (1 - \mu_F) \sum_{j=1}^4 \chi_j \pi_{t-j}^F + \omega_\psi E_{t-1} \psi_t^F + v_t\tag{A.55}$$

$$\begin{aligned}y_t &= \mu_y E_{t-1} y_{t+1} + (1 - \mu_y)(\eta y_{t-1} + (1 - \eta)y_{t-2}) \\ &\quad - \chi(i_t - E_t \pi_{t+1}^H) + \varsigma E_{t-1} \Delta \psi_t^F + \phi E_{t-1} \Delta y_t^* + u_t\end{aligned}\tag{A.56}$$

$$q_t = (1 - \alpha) E_t q_{t+1} + \alpha q_{t-1} - \beta(i_{q,t} - E_t \pi_{q,t+1}) + (i_{q,t}^* - E_t \pi_{q,t+1}^*) + \tau_t\tag{A.57}$$

$$\psi_t^F = q_t - (1 - \gamma) s_t\tag{A.58}$$

$$\Delta s_t \equiv \frac{1}{4}(\pi_t^F - \pi_t^H)\tag{A.59}$$

$$\pi_t = (1 - \gamma) \pi_t^H + \gamma \pi_t^F\tag{A.60}$$

$$\pi_{q,t}^* = \lambda^{\pi^*} \pi_{q,t-1}^* + \zeta_t^{\pi^*}\tag{A.61}$$

$$i_{q,t}^* = \lambda^{i^*} i_{q,t-1}^* + \zeta_t^{i^*}\tag{A.62}$$

$$y_t^* = \lambda^{y^*} y_{t-1}^* + \zeta_t^{y^*}\tag{A.63}$$

$$i_t = 4i_{q,t}\tag{A.64}$$

$$\pi_t = 4\pi_{q,t}\tag{A.65}$$

A.3.3 Estimation results

Series	Transformation	Model Variable
GDP mainland Norway per capita, seasonally adjusted	Log, HP-filtered with $\lambda = 16000$, demeaned	y_t
Quarterly core inflation (KPIJAE) Norway, seasonally adjusted	Annualized, demeaned	π_t^H
Quarterly core inflation imported goods, seasonally adjusted	Annualized, demeaned	π_t^F
3-month nominal money market interest rate Norway (NIBOR)	Annualized, demeaned	i_t
Trade weighted real exchange rate	Log, HP-filtered with $\lambda = 16000$, demeaned	q_t
World output gap, seasonally adjusted (from OECD)	Demeaned	y_t^*
3-month nominal money market interest rate main trading partners	Demeaned	$i_{q,t}^*$
Trade weighted quarterly inflation (KPI), seasonally adjusted	Demeaned	$\pi_{q,t}^*$

Table A.1: List of data series used for estimation of LGM.

Parameter	Prior distribution	Prior mean	Prior st.dev.	Posterior mean	Posterior 95% confidence interval
μ_H	Normal	0.58	0.2	0.6299	0.5548 – 0.7051
α_o	Normal	-0.39	0.2	-0.4622	-0.5025 – -0.4135
α_1	Normal	0.22	0.2	0.0953	-0.0148 – 0.2255
α_2	Normal	0.72	0.2	0.7636	0.6829 – 0.8324
κ_x	Normal	0.28	0.1	0.1948	0.1608 – 0.2260
κ_ψ	Normal	0.04	0.02	0.0479	0.0415 – 0.0579
μ_f	Normal	0.78	0.2	0.6629	0.5962 – 0.7304
χ_0	Normal	1.11	0.2	1.0900	1.0619 – 1.1263
χ_1	Normal	0	0.2	0.0482	-0.0372 – 0.1403
χ_2	Normal	0	0.2	0.0419	-0.0443 – 0.1265
ω_{psi}	Normal	0.56	0.2	0.6198	0.5731 – 0.6617
μ_x	Normal	0.53	0.2	0.4037	0.3672 – 0.4459
η	Normal	1.36	0.2	1.1618	1.1117 – 1.1968
χ	Normal	0.07	0.02	0.0800	0.0718 – 0.0900
ς	Normal	0.11	0.05	0.0506	0.0372 – 0.0636
ϕ	Normal	0.25	0.1	0.2113	0.1783 – 0.2510
α	Beta	0.1	0.05	0.0740	0.0541 – 0.1024
β	Beta	0.9	0.05	0.9749	0.9614 – 0.9939
ρ	Beta	0.75	0.2	0.7055	0.6713 – 0.7350
ϕ_π	Normal	0.375	0.3	0.3848	0.3139 – 0.4568
ϕ_y	Normal	0.125	0.3	0.1988	0.1274 – 0.2556
σ_i	Inverse gamma	0.01	<i>inf</i>	0.0063	0.0054 – 0.0072
σ_{π_H}	Inverse gamma	0.02	<i>inf</i>	0.0132	0.0113 – 0.0150
σ_{π_F}	Inverse gamma	0.06	<i>inf</i>	0.0361	0.0302 – 0.0419
σ_x	Inverse gamma	0.004	<i>inf</i>	0.0078	0.0057 – 0.0101
σ_q	Inverse gamma	0.01	<i>inf</i>	0.0328	0.0280 – 0.0378
σ_{y^*}	Inverse gamma	0.004	<i>inf</i>	0.0047	0.0040 – 0.0053
σ_{π^*}	Inverse gamma	0.003	<i>inf</i>	0.0024	0.0021 – 0.0027
σ_{i^*}	Inverse gamma	0.001	<i>inf</i>	0.0011	0.0010 – 0.0013

Table A.2: Prior and posterior distributions for variables in the LGM model.

Appendix B

Derivation of the implied inflation premium

Let the policy implemented in a given model change from the optimal implementable policy r^{oir} to another policy rule r^{new} , and let the losses measured by the standard loss function 3.5 under these policies be, respectively, L^{oir} and L^{rule} . Following Kuester and Wieland (2010), the implied inflation premium (IIP) measures the increase in the standard deviation of $\bar{\pi}_t$ (in percentage points) when policy changes from r^{oir} to r^{new} that is required to increase the loss to the level L^{rule} while holding the standard deviations of y_t and Δi_t constant. Let the IIP be given by $\Delta\sigma_\pi = \sigma_\pi^{rule} - \sigma_\pi^{oir}$. Then the new loss can be expressed in terms of the loss under the optimal policy, the standard deviation of $\bar{\pi}_t$ under the optimal policy, and the IIP:

$$\begin{aligned} L^{rule} &= (\sigma_\pi^{oir} + \Delta\sigma_\pi)^2 + \lambda_y \sigma_y^2 + \lambda_{\Delta i} \sigma_{\Delta i}^2 & (B.1) \\ &= (\sigma_\pi^{oir})^2 + \lambda_y \sigma_y^2 + \lambda_{\Delta i} \sigma_{\Delta i}^2 + (\Delta\sigma_\pi)^2 + 2\sigma_\pi^{oir} \Delta\sigma_\pi \\ &= L^{oir} + (\Delta\sigma_\pi)^2 + 2\sigma_\pi^{oir} \Delta\sigma_\pi, \end{aligned}$$

where the standard deviations of y_t and Δi are calculated under the optimal policy r^{oir} . From this, we can easily solve for the IIP, $\Delta\sigma_\pi$. The positive solution to the second order equation is given by

$$\Delta\sigma_\pi = \sqrt{L^{rule} - L^{oir} + (\sigma_\pi^{oir})^2} - \sigma_\pi^{oir}. \quad (B.2)$$

This formula can be justified more intuitively by noting that the difference in loss, holding the variances/standard deviations of y_t and Δi_t constant, is equal to the difference in variance

between the two rules,

$$L^{rule} - L^{oir} = (\sigma_{\pi}^{rule})^2 - (\sigma_{\pi}^{oir})^2. \tag{B.3}$$

Solving this equation for σ_{π}^{rule} and then subtracting σ_{π}^{oir} on both sides will give equation B.2.

Appendix C

Optimal implementable rules

The optimal implementable rules in each of the four models are given in table C.1. These rules are of the following type:

$$i_t = \rho_1 i_{t-1} + \rho_2 i_{t-2} + \phi_{\pi,0} \bar{\pi}_t + \phi_{\pi,1} \bar{\pi}_{t-1} + \phi_{\pi,2} \bar{\pi}_{t-2} + \phi_{y,0} y_t + \phi_{y,1} y_{t-1} + \phi_{y,2} y_{t-2}. \quad (\text{C.1})$$

Model	ρ_1	ρ_2	$\phi_{\pi,0}$	$\phi_{\pi,1}$	$\phi_{\pi,2}$	$\phi_{y,0}$	$\phi_{y,1}$	$\phi_{y,2}$
NEMO	1.8	-0.82	1.0	-1.2	0.32	0.27	-0.035	-0.20
Credit NEMO	1.9	-0.89	1.5	-1.9	0.64	0.40	-0.15	-0.20
LGM	1.6	-0.68	0.84	-0.85	0.31	0.85	-0.48	-0.10
NAM	0.37	-0.15	1.24	-0.22	-0.22	0.30	0.24	0.0031

Table C.1: Optimal eight parameter rules in each of the four models.